

SABROE® PRODUCTS 2018

Creating customer confidence



We have no PLANET B
Let's keep our planet cool



SABROE® - Creating customer confidence for a better world

Our customers are our community. We work every day to keep their trust and support their environments so they succeed. Our rigorous engineering and testing enables consistently safe, reliable and high-performing solutions. When our customers are confident, we are successful.

With a long history of product innovation, we always move forward with a focus on leading our customers to greener, safer and more profitable solutions. We deliver the "heart" of our customers' processes and we take our role seriously – from the support of the world's healthy food supply to the energy that fuels our world.

We drive positive changes in the industries we serve as the world champions in green cooling and heating solutions, offering supreme flexibility and relentless quality.



Part of Johnson Controls

The SABROE® product brand is owned by Johnson Controls, a global diversified technology and industrial leader serving customers in more than 150 countries.

We are part of the Building Technologies & Solutions division of Johnson Controls, enabling us to provide SABROE® customers with a comprehensive range of products, systems and services for meeting heating, ventilating, air conditioning and refrigeration needs in industrial, commercial and residential buildings of all kinds.

SABROE® is a registered trademark of Johnson Controls in the United States of America and other countries.

Other trademarks:

CMO, SMC, HPO, HPC, HPX, TCMO, TSMC, SABflex, SAB, ChillPAC, ComPAC, PAC, SABlight, CAFP, DualPAC, HeatPAC, Unisab, CP Optimiser, ISAC, iRIS, AP1000, WDO.

Contents

Business with global goals. page 4

SABROE® products – the big difference. page 6

SABrecip
SABROE recip compressors

SABROE® reciprocating compressors page 10

SABscrew
SABROE screw compressors

SABROE® screw compressors page 18

SABchill
SABROE chiller units

SABROE® chillers. page 26

SABfreze
SABROE freezing units

SABROE® low-temperature chillers page 38

SABheat
SABROE heat pumps

SABROE® heat pumps page 40

SABcontrol
SABROE control systems

SABROE® control systems page 52

SABROE® customised solutions page 72

AfterMarket solutions page 75

SABROE® End-of-Line test centre page 80

Compressors

Chillers

Heat pumps

Control systems

Customised

AfterMarket

SABROE

Business with global goals



Johnson Controls believes in doing well by doing good

"We will design and deliver increasingly sustainable products, services and solutions that help our customers improve their energy efficiency, reduce their carbon footprint, and achieve their environmental goals.

Leading by example, we will improve our own environmental performance and that of our supply chain. We will protect our environment through recycling and reducing greenhouse gases, energy, water and waste."

Determined to do something

The seventeen UNDP Sustainable Development Goals (SDGs) came into effect in January 2016, as part of a worldwide push to implement concrete measures to help end poverty, protect the planet and ensure peace and prosperity for everyone.



As a world leader in the commercial application of innovative thinking and sustainable technology, Johnson Controls – and its SABROE business unit – strongly support, endorse and encourage implementing the UNDP SDGs to ensure good business with a minimum of environmental impact. But we are only going to achieve such global goals if we all actively support and comply with them, and pass on the message about their importance.

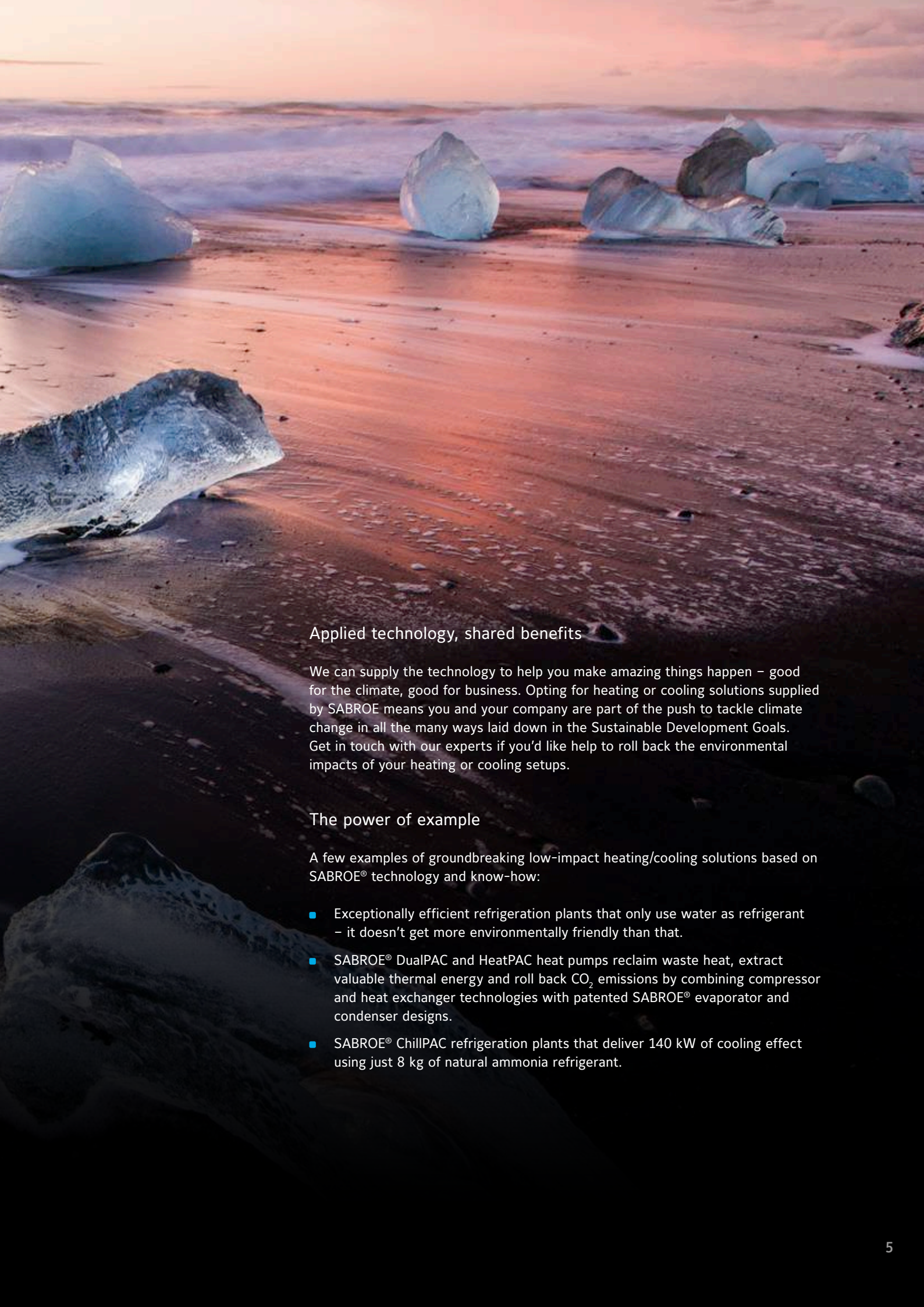

Applied technology, shared benefits

We can supply the technology to help you make amazing things happen – good for the climate, good for business. Opting for heating or cooling solutions supplied by SABROE means you and your company are part of the push to tackle climate change in all the many ways laid down in the Sustainable Development Goals. Get in touch with our experts if you'd like help to roll back the environmental impacts of your heating or cooling setups.

The power of example

A few examples of groundbreaking low-impact heating/cooling solutions based on SABROE® technology and know-how:

- Exceptionally efficient refrigeration plants that only use water as refrigerant – it doesn't get more environmentally friendly than that.
- SABROE® DualPAC and HeatPAC heat pumps reclaim waste heat, extract valuable thermal energy and roll back CO₂ emissions by combining compressor and heat exchanger technologies with patented SABROE® evaporator and condenser designs.
- SABROE® ChillPAC refrigeration plants that deliver 140 kW of cooling effect using just 8 kg of natural ammonia refrigerant.

SABROE® products – the big difference

The equipment you need – now and in the future

We provide the equipment you need to put thermal transfers to work in industrial and commercial installations – from a full spectrum of refrigeration compressors of all kinds to industrial chillers and heat pumps.

SABROE® systems are designed to be versatile and future-compatible, making it easy for you to repurpose, retrofit, expand and upgrade your installations and your thermal management capabilities, whenever the need arises.

Documented capabilities and performance

When you sign up for SABROE® solutions and equipment, we make sure you know exactly what you're getting. You don't just get average performance figures – you get exact, documented capabilities for your particular set-up, as tested at the state-of-the-art SABROE® test centre in Denmark, prior to delivery.

Full satisfaction – no surprises

We're committed to full transparency and helping our customers as much as possible. That's why we also use the same data and documentation in all subsequent SABROE® calculations about your set-up.

We document everything – and share the results with you and your staff, so there are no unwelcome surprises, and you can put our specialist know-how to best possible use.



Know-how steers you away from risk



Reap the full potential of your equipment purchases

In the world of industrial refrigeration, the equipment you buy – whether standardised or individually customised – is just part of the overall picture.

You only reap the full potential of your equipment purchases when they are effectively integrated into your existing set-up and when all the operating parameters are fine-tuned to ensure you maximum cost-effectiveness.

Prevention is better than cure

With over a century of heavyweight practical experience in everything even remotely related to industrial refrigeration compressors, SABROE® experts know pretty much all the on-site pitfalls, glitches and bottlenecks likely to occur.

This means that when you specify SABROE® equipment, you get more than you'd normally expect.

Our unique combination of market-leader expertise and first-mover technology capabilities means that we know how to help prevent difficulties and downtime, rather than spending time and money dealing with them once they've cropped up.

Screw or reciprocating compressor?

There is no simple answer to this constantly recurring question. Both technologies are viable alternatives for use in almost all installations, and both types are normally capable of doing the job.

Our sole aim is to make sure you get the best out of your particular set-up, and the best profit margins from your operations.

And to do that we can supply state-of-the-art compressors of both types, covering the full scope of normal capacities.

The criteria you have to balance normally include:

- Required capacity
- Operating conditions
- Available space
- Part-load requirements
- Temperature levels
- Energy consumption
- Choice of refrigerant
- Environmental concerns
- Maintenance issues
- Peak vs average ratio.

Variable-speed drive - only using what's needed

The vast majority of SABROE compressor models (both reciprocating and screw types) are available with variable-speed drive (VSD) to provide stepless control of your compressor capacity.

This helps you achieve maximum cooling effect using a minimum of energy, as well as keeping operating costs to the absolute minimum. The combination of a frequency converter, a VSD motor and the Unisab III integrated systems controller makes it possible to run the drive motor at speeds that match the load at any given time.

This enables you to reduce energy costs by as much as 30% compared with traditional fixed-speed compressors.



SABROE compressor programme

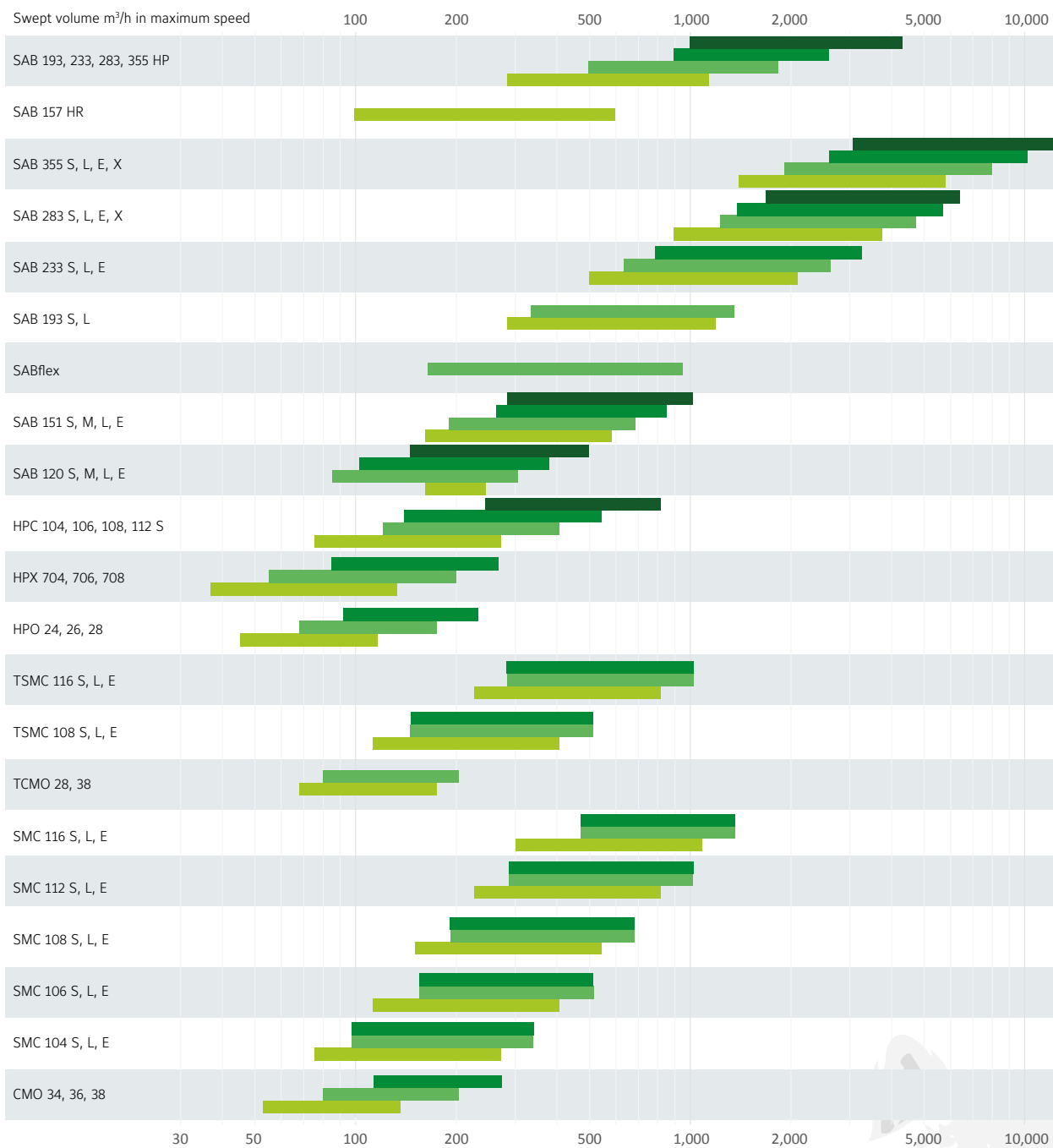

Swept volume m³/h in maximum speed
 (Reciprocating compressors at 50/60 Hz. Screw compressors at 50/60/70/100 Hz)

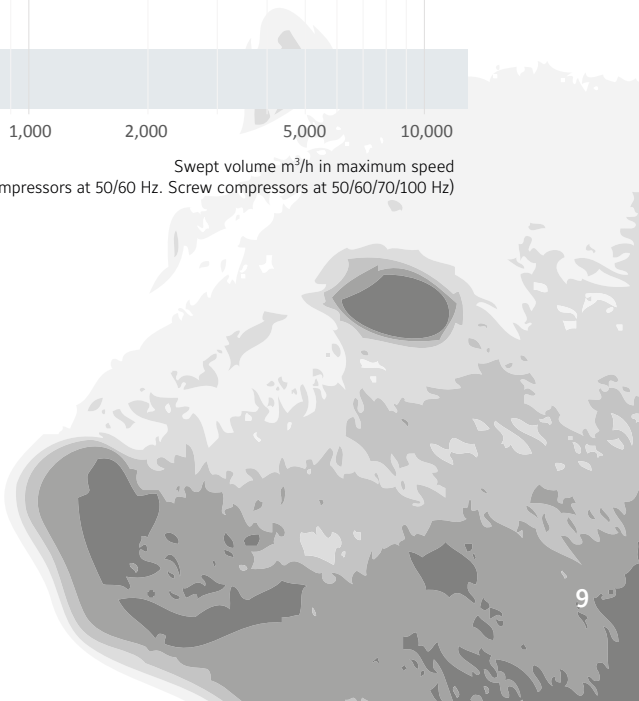

SABROE CMO reciprocating compressor units

Small single-stage compressors with swept volumes of 100–270 m³/h

CMO compressor units are small units specially designed for use in smaller-scale refrigeration installations where reliability is a particular concern, and uninterrupted service a big priority.

They are an economical, low-maintenance solution for smaller-scale, heavy-duty refrigeration installations, and are most commonly used as stand-alone units operating at full load, or as small back-up compressors.

Range

Six different models are available to provide swept volumes of between 97 and 273 m³/h.



CMO 24 reciprocating compressor unit with Unisab III systems controller

Advantages	Benefits
High coefficient of performance (COP), with excellent performance even under part-load conditions	Low power consumption, which greatly reduces operating costs
Special design ensures low noise and vibration	Wider range of possible mounting locations, and minimal expenditure on noise attenuation systems
Variable-speed drive (optional) provides stepless capacity control over the entire operating range	Power consumption and operating costs kept to a minimum
Repairs can be undertaken <i>in situ</i> , without removing the compressor	Lower repair costs and less downtime
Easy to access for service, with limited spare parts requirements	Easy, inexpensive maintenance, which helps limit downtime and reduce operating costs

Options

- Unisab III systems controller
- Variable-speed drive line (Unisab always included)
- Gauges, thermometers and temperature/pressure control switches
- Extended cylinder capacity control
- Oil level regulator (for use in parallel systems)
- ATEX-compliant configuration
- Oil separators with coalescing element
- Special vibration dampening.

Model	Number of cylinders	Swept volume at 1500 rpm m ³ /h	Swept volume at 1800 rpm m ³ /h	R717 *				Unit dimensions in mm			Weight excluding motor kg	Sound pressure level at 1500 rpm db(A)	Sound pressure level at 1800 rpm db(A)
				Nominal capacities in kW at 1500 rpm Single/high-stage		Nominal capacities in kW at 1800 rpm Single/high-stage		L	W	H			
				-10/+35°C	0/+40°C	-10/+35°C	0/+40°C						
CMO 24	4	97	116	52	80	62	96	1400-2150	800	900	480	69	72
CMO 26	6	146	175	78	120	93	144	1450-2175	800	900	520	71	73
CMO 28	8	194	233	104	160	125	192	1475-2200	800	900	550	72	74
CMO 34	4	114	136	61	94	73	113	1400-2150	800	900	480	70	73
CMO 36	6	170	204	91	141	109	169	1450-2175	800	900	520	72	74
CMO 38	8	227	273	122	187	146	225	1475-2200	800	900	550	73	75

* Other refrigerants available on request

Nominal capacities are based on:
1500 rpm at 50 Hz.
1800 rpm at 60 Hz or VSD.

For R717

2K liquid subcooling and 0.5K non-usable suction superheat.

Design pressure, HP side: 28 bar

Design pressure, LP side: 18 bar

Differential pressure: 25 bar.

Sound pressure levels in free field, over reflecting plane and one metre distance from the compressor block.

Min./max. speed	R717
CMO 20	700-1800 rpm
CMO 30	700-1800 rpm

SABROE SMC reciprocating compressor units

Large single-stage compressors with swept volumes of 200–1350 m³/h

SMC compressor units are ideal for use in medium-sized refrigeration installations where reliable service is a major priority. They are particularly effective under part-load conditions.

SABROE SMC compressors are world-renowned for their exceptional reliability, making them an economical, low-maintenance solution for heavy-duty refrigeration, using all common refrigerants.

Range

Fifteen different models are available to provide swept volumes of between 226 and 1357 m³/h.



SMC 116 single-beam reciprocating compressor unit with Unisab III systems controller

Advantages

High coefficient of performance (COP), with excellent performance under part-load conditions

Variable-speed drive provides stepless capacity control over the entire operating range

Condition-based service intervals embedded in the controls equipment

Easy to access for service, with limited spare parts requirements

Special oil separator design based on coalescer technology

Benefits

Low power consumption, which greatly reduces operating costs

Power consumption and operating costs kept to a minimum

Minimum downtime and low service costs due to extremely long service intervals

Easy, inexpensive maintenance, which helps limit downtime and reduce operating costs

Low oil carry-over, which cuts back on oil costs



Options

- Unisab III systems controller
- Variable-speed drive line (Unisab always included)
- Gauges, thermometers and temperature/pressure control switches
- Extended cylinder capacity control
- Oil level regulator (for use in parallel systems)
- ATEX-compliant configuration
- Special vibration dampening.

Model	Number of cylinders	Swept volume at 1500 rpm m ³ /h	Swept volume at 1800 rpm m ³ /h	R717 *						Unit dimensions in mm			Weight excluding motor kg	Sound pressure level at 1500 rpm db(A)	Sound pressure level at 1800 rpm db(A)
				Nominal capacities in kW at 1500 rpm			Nominal capacities in kW at 1800 rpm			L	W	H			
				Single/high-stage		Booster	Single/high-stage		Booster						
				-10/+35°C	0/+40°C	-40/-10°C	-10/+35°C	0/+40°C	-40/-10°C						
SMC 104 S	4	226	271	127	195	35	153	235	42	2261-2865	1213	1229	1195	79	82
SMC 104 L	4	283	339	165	250	47	198	300	57	2261-2865	1213	1229	1215	80	83
SMC 104 E	4	339	N/A	203	306	58	N/A	N/A	N/A	2261-2865	1213	1229	1220	80	83
SMC 106 S	6	339	407	191	293	53	229	352	64	2286-2890	1267	1247	1380	81	83
SMC 106 L	6	424	509	247	375	71	297	450	85	2286-2890	1267	1247	1400	82	84
SMC 106 E	6	509	N/A	304	459	87	N/A	N/A	N/A	2286-2890	1267	1247	1410	82	84
SMC 108 S	8	452	543	255	391	71	306	469	85	2311-2915	1361	1247	1595	82	84
SMC 108 L	8	566	679	330	500	94	396	600	113	2311-2915	1361	1247	1630	83	85
SMC 108 E	8	679	N/A	406	612	116	N/A	N/A	N/A	2311-2915	1361	1247	1650	83	85
SMC 112 S	12	679	814	382	586	106	459	703	127	3279-3687	1475	1448	2255	83	85
SMC 112 L	12	848	1018	495	750	141	593	900	169	3279-3687	1475	1448	2280	83	86
SMC 112 E	12	1018	N/A	609	918	173	N/A	N/A	N/A	3279-3687	1475	1448	2330	83	86
SMC 116 S	16	905	1086	510	782	141	611	938	170	3329-3737	1536	1445	2505	84	86
SMC 116 L	16	1131	1357	659	1000	188	791	1200	226	3329-3737	1536	1445	2535	84	87
SMC 116 E	16	1357	N/A	812	1224	231	N/A	N/A	N/A	3329-3737	1536	1445	2590	84	87

* Other refrigerants available on request

Nominal capacities are based on:
1500 rpm at 50 Hz.
1800 rpm at 60 Hz or VSD.

For R717

2 K liquid subcooling and 0.5 K non-usable suction superheat.

Design pressure, HP side: 28 bar
Design pressure, LP side: 18 bar
Differential pressure: 25 bar.

Sound pressure levels in free field, over reflecting plane and one metre distance from the compressor block.

Min./max. speed	R717
SMC S-series	500-1800 rpm
SMC L-series	500-1800 rpm
SMC E-series	500-1500 rpm

All information is subject to change without notice.

SABROE HPO/HPC/HPX high-pressure reciprocating compressor units

High-pressure hybrids of CMO and SMC reciprocating compressors, with swept volumes of 100–800 m³/h

The blocks of the compressor units in the HPO/HPC/HPX range are cast in high-strength ductile iron, making them particularly strong and capable of operating under exceptionally high pressures.

This results in condensing temperatures of up to 90°C, and makes HPX and HPO/HPC compressors ideal for use in conjunction with heat pumps and hot water applications, and as an extra “supercharge” stage in traditional ammonia plants. The renowned SABROE high-pressure compressors are ideal for use with either ammonia or CO₂ as refrigerant.

SABROE high-pressure compressors provide exceptional reliability and big savings on operating costs, because they are based on the high-volume CMO and SMC compressors, and they share the majority of castings and parts.

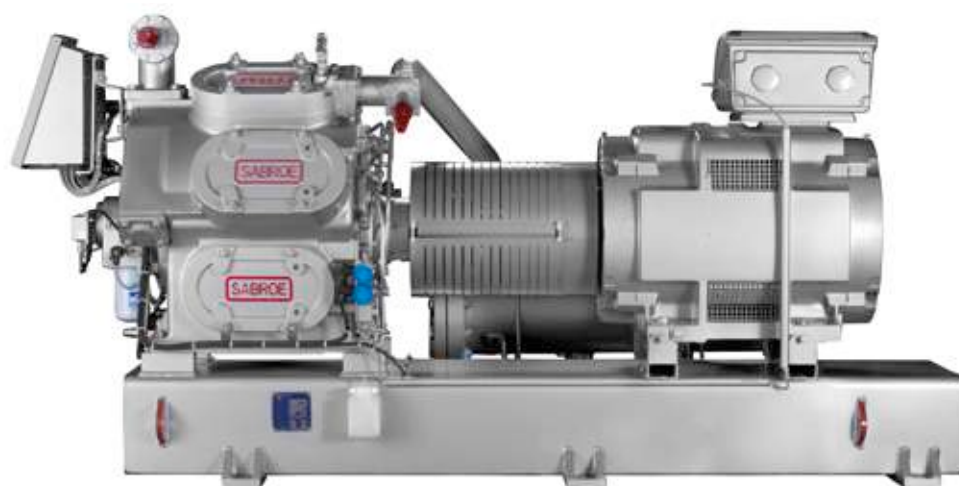

HPC 108 single-stage reciprocating compressor unit (50 bar) with Unisab III systems controller

Advantages	Benefits
High coefficient of performance (COP), with excellent performance under part-load conditions	Low power consumption, especially under part-load conditions. This greatly reduces operating costs
Variable-speed drive (optional) provides stepless capacity control over the entire operating range	Power consumption and operating costs kept to a minimum
Provides exceptionally high condensing temperatures – up to 90°C	Matches radiator temperature in most domestic/commercial heating systems, making HPO/HPC/HPX units ideal in district heating, etc
Designed for easy service access, and repairs can be undertaken <i>in situ</i> , without removing the compressor	Lower repair and maintenance costs, and less downtime
Special oil separator design based on coalescer technology	Low oil carry-over, which cuts back on oil costs

Range

Nine different models are available to provide swept volumes of between 97 and 814 m³/h.

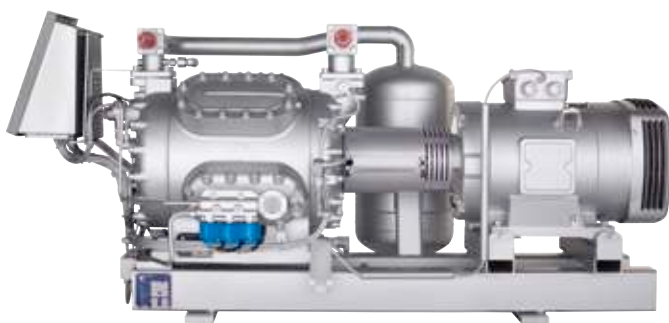

Options

- Variable-speed drive line
- Gauges, thermometers and temperature/pressure control switches
- Extended cylinder capacity control
- ATEX-compliant configuration
- Special vibration dampening.

Model	Number of cylinders	Swept volume at 1500 rpm m ³ /h	Swept volume at 1800 rpm m ³ /h	Nominal capacities in kW at 1800 rpm						Unit dimensions in mm			Weight excluding motor kg	Sound pressure level at 1800 rpm dB(A)
				Heating		Cooling		Defrosting		L	W	H		
				R717		R717	R744	R744						
				+35/+74°C	+35/+90°C	0/+55°C	-50/-10°C	-15/+8°C	-40/+10°C					
HPO 24	4	97	116	332	N/A	83	116	441	N/A	1580-1930	835	985	510	77
HPO 26	6	146	175	497	N/A	125	174	661	N/A	1600-1950	940	985	550	78
HPO 28	8	194	233	663	N/A	167	232	881	N/A	1620-1970	940	985	580	80
HPC 104 S	4	226	271	781	N/A	198	226*	N/A	N/A	2261-2865	1305	1214	1340	83
HPC 106 S	6	339	407	1171	N/A	297	338*	N/A	N/A	2286-2890	1345	1260	1580	84
HPC 108 S	8	452	543	1560	N/A	396	451*	N/A	N/A	2311-2915	1486	1247	1660	85
HPC 112 S	12	679	814	N/A	N/A	594	677*	N/A	N/A	3279-3687	1525	1448	2520	86
HPX 704	4	111	133	380	356	95	133	N/A	232	2261-2865	1213	1214	1220	82
HPX 706	6	166	200	570	535	143	200	N/A	347	2286-2890	1267	1260	1440	84
HPX 708	8	222	266	760	713	190	266	N/A	463	2311-2915	1278	1260	1510	85
HPX 712	12	333	399	1140	1069	286	400	N/A	695	3279-3687	1345	1448	2430	86
HPX 716	16	443	532	1520	1426	381	533	N/A	926	3329-3737	1356	1445	2600	87

* at 1500 rpm

For HPO

Design pressure, HP side: 50 bar
Design pressure, LP side: 26 bar
Differential pressure: 25 bar.

For HPC

Design pressure, HP side: 50 bar
Design pressure, LP side: 26 bar
Differential pressure: 25 bar.

For HPX

Design pressure, HP side: 60 bar
Design pressure, LP side: 26 bar
Differential pressure: 40 bar.

Nominal capacities are based on:
1500 rpm at 50 Hz.
1800 rpm at 60 Hz or VSD.

For R744

2 K liquid subcooling and 10 K usable suction superheat for R744.

For R717

2 K liquid subcooling and 0.5 K non-usable suction superheat.

Sound pressure levels in free field, over reflecting plane and one metre distance from the compressor block.

Min./max. speed	R717	R744
HPO 20	700-1800 rpm	700-1800 rpm
HPC 100	500-1800 rpm	500-1500 rpm
HPX 700	500-1800 rpm	500-1800 rpm

All information is subject to change without notice.

SABROE TCMO/TSMC two-stage reciprocating compressor units

Two-stage versions of CMO and SMC reciprocating compressors, with swept volumes of 150–1000 m³/h

SABROE TCMO/TSMC two-stage reciprocating compressors are an economical operating alternative to single-stage compressors in smaller low-temperature refrigeration installations.

TCMO/TSMC compressor units are also ideal for medium-size industrial refrigeration installations that involve a big temperature range, such as freezer installations. Furthermore, these units are easy to customise with intermediate cooling systems.

Using a two-stage set-up built together as a single unit helps avoid equipment duplication – and thus reduce costs and save space.

Range

Eight different models are available to provide swept volumes of between 146 and 1018 m³/h.



TSMC 108 two-stage reciprocating compressor unit shown with closed flash inter-stage cooling system and Unisab III systems controller

Advantages	Benefits
Splitting the temperature lift into two separate stages reduces overall energy consumption	Two-stage installations are relatively cost-effective, which helps reduce energy costs
Relatively small footprint	Can be installed in relatively small locations, or where space is limited
High coefficient of performance (COP), with excellent performance under part-load conditions	Low power consumption, which greatly reduces operating costs
Variable-speed drive (optional) provides stepless capacity control over the entire operating range	Power consumption and operating costs kept to a minimum

Options

- Unisab III systems controller
- Gauges, thermometers and temperature/pressure control switches
- Oil level regulator (for use in parallel systems)
- ATEX-compliant configuration
- Special vibration dampening.

Intermediate cooling system options

In plants with multiple two-stage compressors, TCMO/TSMC units can be connected to a shared intermediate cooler, in a separate installation.

Alternatively, a range of built-on intermediate cooling systems are available, as optional equipment.

- Injection inter-stage gas cooling without liquid subcooling
- Injection inter-stage gas cooling with liquid subcooling in a shell-and-tube heat exchanger
- Closed flash inter-stage cooling in a shell-and-coil intermediate cooler, with liquid subcooling in the coil.

Model	Number of cylinders low/high-pressure side	Swept volume at 1500 rpm m ³ /h	Swept volume at 1800 rpm m ³ /h	Nominal capacities in kW R717 *		Unit dimensions in mm			Weight excluding motor kg	Sound pressure level at 1500 rpm dB(A)	Sound pressure level at 1800 rpm dB(A)
				1500 rpm	1800 rpm	L	W	H			
TCMO 28	6 / 2	146	175	20	24	1400-1750	700	1000	500	68	70
TCMO 38	6 / 2	170	205	23	28	1400-1750	700	1000	500	69	71
TSMC 108 S	6 / 2	339	407	50	60	2311-2915	1052	1247	1746	80	82
TSMC 108 L	6 / 2	424	509	66	79	2311-2915	1052	1247	1781	81	83
TSMC 108 E	6 / 2	509	N/A	81	N/A	2311-2915	1052	1247	1796	81	83
TSMC 116 S	12 / 4	679	814	100	121	3329-3737	1327	1445	2791	81	83
TSMC 116 L	12 / 4	848	1018	133	159	3329-3737	1327	1445	2841	82	84
TSMC 116 E	12 / 4	1018	N/A	163	N/A	3329-3737	1327	1445	2891	83	84

* Other refrigerants are available on request.

Nominal capacities are based on:
1500 rpm at 50 Hz.
1800 rpm at 60 Hz or VSD.

For R717

2K liquid subcooling, 0.5 K non-usable suction super-heat and liquid subcooling in intermediate cooler to 10K above intermediate temperature.

For TCMO

Design pressure, HP side: 28 bar
Design pressure, LP side: 18 bar
Differential pressure: 25 bar.

For TSMC

Design pressure, HP side: 28 bar
Design pressure, LP side: 18 bar
Differential pressure: 25 bar.

Sound pressure levels in free field, over reflecting plane and one metre distance from the compressor block.

Min./max. speed	R717
TCMO 20	700-1800 rpm
TCMO 30	700-1800 rpm
TSMC S	500-1800 rpm
TSMC L	500-1800 rpm
TSMC E	500-1500 rpm

SABROE SABflex screw compressor units

Small screw compressor units with swept volumes of 160–950 m³/h

SABROE SABflex screw compressors are specially designed for installations where the requirements for refrigeration capacity vary over time. These smaller-size units are optimised to ensure exceptional part-load performance as well as the best possible energy efficiency.

Everything about these units is configured for use with variable-speed drive (VSD), doing away with the traditional capacity slide and ensuring skip-free performance across the entire 1,000–6,000 rpm capacity range.

The VSD drive can be mounted on the unit, or separately in an appropriate switchboard room.

Range

SABflex units are available to provide swept volumes of 160–950 m³/h at 6000 rpm using a high-speed motor, or 160–570 m³/h at 3600 rpm using a standard motor.

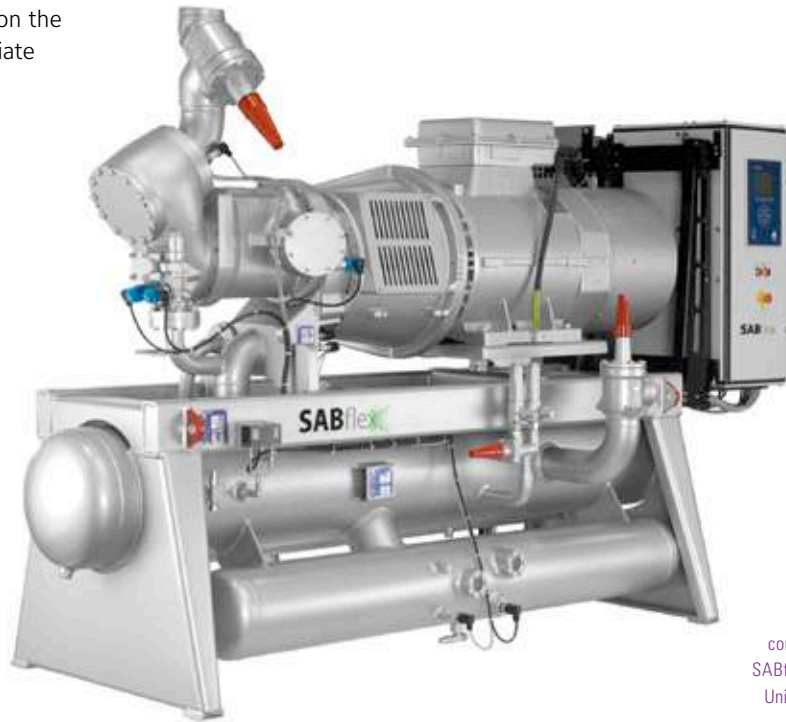

SABflex screw compressor unit with SABflex VSD panel and Unisab III as standard

Advantages	Benefits
Stepless, skip-free capacity control ensures that output always matches requirements	Lowest possible operating costs and rapid return on investment
Consistently high performance at both full and part load	Maximum part-load efficiency and low life cycle costs
Uncomplicated design with fewer moving parts and very low vibration	Exceptional reliability and low maintenance costs
Supports Condition Based Service (CBS) schedules and the SABROE Block Swap Concept	Optimised service/maintenance intervals, and unscheduled downtime minimised
Standardised electrical panel and drive line, factory tested prior to delivery	Rapid commissioning and maximum in-service reliability

Options

- Thermosyphon and water-cooled oil coolers, with 3-way oil temperature control valve
- Demand oil pump – controlled by Unisab III systems controller
- Dual Super-filter oil filters
- Complete economiser system.

Only for use with ammonia (R717) as refrigerant.

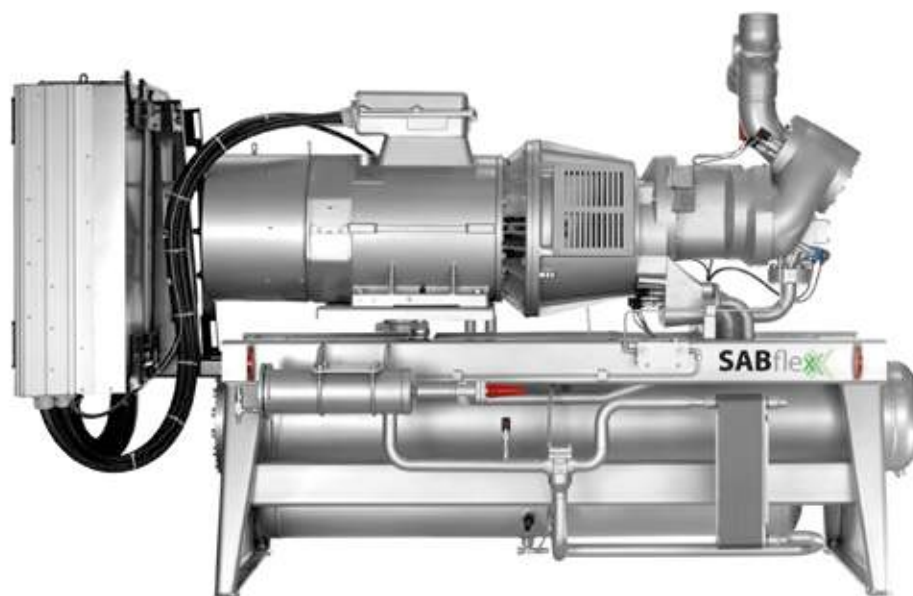

SABflex screw
compressor unit

Model	Swept volume at 3600 rpm m ³ /h	Swept volume at 6000 rpm m ³ /h	Nominal capacities in kW for R717			Unit dimensions in mm L x W x H	Weight excluding motor/oil kg	Sound pressure level at 3600 rpm dB(A)	Sound pressure level at 6000 rpm dB(A)
			High stage -10/+35°C	Booster -40/-10°C	With economiser -40/+35°C				
SABflex	570	950	592	187	173	3250 x 1450 x 2100	2200	83	89

Sound pressure levels in free field, over reflecting plane and one metre distance from the unit.

All information is
subject to change
without notice.

SABROE SAB screw compressor units

Small single-stage compressors with swept volumes of 200–1000 m³/h

SABROE SAB screw compressors are designed and configured to tackle smaller-scale industrial refrigeration requirements where a combination of exceptional reliability, high performance and low operating costs is essential.

These small units can be used with all the most common refrigerants and process gases, and all the components are selected for good accessibility and ease of service, ensuring cost-effective maintenance.

Range

Eight different models are available to provide swept volumes of 204–1016 m³/h.



SAB 151 screw compressor unit with Unisab III systems controller

Advantages	Benefits
Variable-speed drive and stepless capacity control ensure that capacity is always adjusted to suit requirements	Maximum part-load efficiency and lowest possible operating costs
SAB screw compressor units are all equipped with a Unisab III systems controller	More efficient operating profile, less downtime and longer service life
Cold Start valve lubricates the compressor, with no oil pump needed	Lower operating costs and less maintenance
SuperFilter II oil filter captures 99% of all particles larger than 5 microns	Longer bearing life, providing maximum reliability and savings on both maintenance and replacement
Space-saving design with small footprint	Significant reductions in space requirements

Options

- Variable-speed drive
- Thermosyphon and water-cooled oil coolers, with 3-way oil temperature control valve
- Liquid injection oil cooling (EZ Cool)
- Dual SuperFilter II oil filters (on SAB 151 models only)
- Complete economiser systems
- Demand oil pump – controlled by Unisab III systems controller
- Sensors and transmitters for control by external PLC systems.

Model	Swept volume at 3000 rpm* m ³ /h	Swept volume at 3600 rpm* m ³ /h	Nominal capacities in kW at 3600 rpm			Unit dimensions in mm L x W x H	Weight excluding motor/oil kg	Sound pressure level at 3000 rpm dB(A)	Sound pressure level at 3600 rpm dB(A)
			R717		With economiser R717				
			High-stage -10/+35°C	Booster -40/-10°C					
SAB 120 S*	204	245	145	44	44	2200 x 1300 x 1500	1200	85	87
SAB 120 M	255	306	191	58	58	2200 x 1300 x 1500	1200	86	88
SAB 120 L	316	379	243	73	73	2200 x 1300 x 1500	1300	88	90
SAB 120 E	413	496	325	98	99	2200 x 1300 x 1500	1300	89	91
SAB 151 S	484	581	373	116	106	3000 x 1450 x 1800	2050	90	92
SAB 151 M	571	685	448	139	127	3000 x 1450 x 1800	2050	91	93
SAB 151 L	708	850	565	175	160	3000 x 1450 x 1800	2050	91	93
SAB 151 E	847	1016	680	211	193	3000 x 1450 x 1800	2050	92	94

2-pole motor:

3000 rpm at 50 Hz.
3600 rpm at 60 Hz or VSD.

* 4-pole motor (for SAB 120 S):

1500 rpm at 50 Hz.
1800 rpm at 60 Hz or VSD.

Sound pressure levels in free field, over reflecting plane and one metre distance from the unit.

For R717:

2 K liquid subcooling and 0.5 K non-usable suction superheat.

Min./max. speed	R717
SAB 120 S	1000-1800
SAB 120 M-L-E	1000-3600
SAB 151 S-M-L-E	1000-3600

SABROE SAB screw compressor units

Large single-stage compressors with swept volumes of 850–11000 m³/h

The bigger models of SABROE SAB screw compressors are specifically engineered to deal with larger-scale industrial refrigeration installations in which requirements prioritise exceptional reliability, high performance and low operating costs. All the components are designed and configured to ensure low maintenance costs as a result of good accessibility and ease of service.

Like their smaller counterparts, these large-capacity compressor units can be used with all common refrigerants and process gases.

Range

Thirteen different models are available to provide swept volumes of 848–11016 m³/h.



SAB 233 screw compressor unit with Unisab III systems controller

Advantages	Benefits
Variable-speed drive and stepless capacity control ensures that capacity is always adjusted to suit requirements	Maximum part-load efficiency and lowest possible operating costs
SAB screw compressor units are all equipped with a Unisab III systems controller	More efficient operating profile, less downtime and longer service life
Cold Start valve lubricates the compressor, with no oil pump needed	Lower operating costs and less maintenance
SuperFilter II oil filter captures 99% of all particles larger than 5 microns	Longer bearing life, providing maximum reliability and savings on both maintenance and replacement
Space-saving design with small footprint	Significant reductions in space requirements
Compact oil separator	Highly efficient oil carry-over as a result of two-stage separation

Options

- Variable-speed drive
- Thermosyphon and water-cooled oil coolers, with 3-way oil temperature control valve
- Liquid injection oil cooling (EZ Cool)
- Dual external oil filters (SuperFilter II type)
- Complete economiser systems
- Demand oil pump – controlled by Unisab III systems controller
- Sensors and transmitters for control by external PLC systems.

Model	Swept volume at 3000 rpm m ³ /h	Swept volume at 3600 rpm m ³ /h	Nominal capacities in kW at 3600 rpm			Unit dimensions in mm L x W x H	Weight excluding motor/oil kg	Sound pressure level at 3000 rpm dB(A)	Sound pressure level at 3600 rpm dB(A)
			R717		With economiser R717 -40/+35°C				
			High stage -10/+35°C	Booster -40/-10°C					
SAB 193 S	848	1018	653	194	193	3150 x 1500 x 1800	2700	84	86
SAB 193 L	1131	1358	872	260	258	3250 x 1500 x 1900	2800	84	86
SAB 233 S	1494	1792	1172	344	334	3700 x 1700 x 2100	4600	86	88
SAB 233 L	1880	2257	1477	484	421	3700 x 1800 x 2200	4750	86	88
SAB 233 E	2323	2788	1826	537	520	3700 x 1800 x 2200	4800	86	88
SAB 283 S	2676	3211	2096	616	597	3700 x 1800 x 2250	5500	88	90
SAB 283 L	3370	4044	2638	776	752	4150 x 1900 x 2650	5850	88	90
SAB 283 E	4055	4865	3159	929	901	4450 x 2100 x 2850	7650	88	90
SAB 355 S	4192	5031	3236	963	917	4550 x 2350 x 3500	10000	89	91
SAB 283 X	4580	5496	3592	1056	1025	4600 x 2100 x 2850	8950	88	90
SAB 355 L	5716	6860	4369	1299	1240	4700 x 2350 x 3500	10000	89	91
SAB 355 E	7275	8730	5550	1630	1576	4850 x 2350 x 3500	10200	89	91
SAB 355 X	9180	11016	NA	2053	1966	5000 x 2350 x 3500	10400	89	91

2-pole motor:

3000 rpm at 50 Hz.
3600 rpm at 60 Hz or VSD.
4200 rpm at 70 Hz or VSD.

Sound pressure levels in free field, over reflecting plane and one metre distance from the unit.

For R717:
2 K liquid subcooling and 0.5 K non-usable suction superheat.

Min./max. speed	R717
SAB 193	1000-4200
SAB 233	1000-3800
SAB 283	1000-3600
SAB 355	1000-3600

All information is subject to change without notice.

SABROE SAB high-pressure screw compressor units

Variable-speed high-pressure screw compressor units with swept volumes of 100–4200 m³/hour, for use with ammonia or CO₂ as refrigerant

These unique high-pressure compressor units are ideal for large site-built ammonia heat pump installations that condense at either 90°C or 72°C. They are also the ideal choice for larger CO₂ systems or low-temperature two-stage freezer installations, such as carbon dioxide-ammonia (R744–R717) cascade refrigeration systems.

Using CO₂ as refrigerant makes it possible to make big savings on installation, piping and compressor costs because a single compressor unit can replace multiple compressors using traditional refrigerants.

SABROE SAB high-pressure screw compressors are specially designed for variable-speed operation and maximum flexibility, doing away with the traditional capacity limitations of slide-valve technology. The capacity range of all SAB models extends from 1000rpm to maximum rpm.

The SAB 193, 233, 283 and 355 high-pressure configurations, all ductile iron-cased versions of the large SABROE compressor units, provide substantial base load capacities along with providing exceptional flexibility in frequency converter operation. This ensures the robustness and reliability derived from the thousands of compressors in long-term service in refrigeration plants worldwide.



SAB 193 high-pressure screw compressor unit with Unisab III systems controller

Advantages	Benefits
High-pressure units designed specifically for applications that use CO ₂ or ammonia as refrigerant	Makes it possible to undertake freezing and defrosting in one single stage, or to utilise waste heat
Stepless, skip-free capacity control ensures that output always matches requirements	Lowest possible operating costs and rapid return on investment
Consistently high performance at both full and part load	Maximum part-load efficiency and low life cycle costs
Space-saving small footprint, with fewer moving parts and very low vibration	Exceptional reliability and low maintenance costs
Supports Condition Based Service (CBS) schedules	Optimised service/maintenance intervals, with a minimum of unscheduled downtime

Options

- Variable-speed drive
- Thermosyphon and water-cooled oil coolers, with 3-way oil temperature control valve
- Liquid injection oil cooling (EZ Cool)
- Dual external oil filters (SuperFilter II type)
- Complete economiser systems
- Demand oil pump – controlled by Unisab III systems controller
- Sensors and transmitters for control by external PLC systems.

For R717, 40 bar

Model	Max. rpm	Swept volume at max. rpm m ³ /h	Capacities in kW including economiser +4/72°C R717			Capacities in kW including economiser at max. rpm +32/72°C, R717			Unit dimensions in mm L x W x H	Weight excluding motor/oil kg	Sound pressure level at max. rpm dB(A)
			Cooling	Heating	COP _{line} Heating/cooling	Cooling	Heating	COP _{line} Heating/cooling			
SAB 193 HP	4200	1188	1270	1797	3.41/2.41	2822	3399	5.90/4.90	3150 x 1500 x 1800	2700	90
SAB 233 HP	3800	1890	2040	2866	3.47/2.47	4576	5466	6.15/5.51	3700 x 1700 x 2100	4600	90
SAB 283 HP	3600	3211	3437	4817	3.49/2.49	7731	9229	6.16/5.16	3700 x 1800 x 2250	5500	92
SAB 355 HP	3600	5030	5273	7472	3.40/2.40	11933	14330	5.98/4.98	4600 x 2400 x 3500	10000	93

For R717, 60 bar

Model	Swept volume at 6000 rpm m ³ /h	Capacities in kW at 6000 rpm R717			Unit dimensions in mm L x W x H	Weight excluding motor/oil kg	Sound pressure level dB(A)
		+40/82°C	+30/82°C	+20/82°C			
SAB 157 HR	596	1912	1503	1148	3300 x 1500 x 2100	2600	on request

For R744

Model	Max rpm	Swept volume at max. rpm m ³ /h	Capacities in kW R744		Unit dimensions in mm L x W x H	Weight excluding motor/oil kg	Sound pressure level at max. rpm dB(A)
			-40/-5°C	-50/-5°C			
SAB 157 HR	6000	596	853	574	3300 x 1500 x 2100	2600	on request
SAB 193 HP	4200	1188	1711	1159	3150 x 1500 x 1800	2700	88
SAB 233 HP	3800	1890	2773	1875	3700 x 1700 x 2100	4600	88
SAB 283 HP	3600	2675	4801	3244	3700 x 1800 x 2250	5500	90
SAB 355 HP	3600	4192	7393	4987	4600 x 2400 x 3500	10000	91

All SABROE high-pressure screw compressors are available on request.

Design pressure for SAB 193 HP, SAB 233 HP, SAB 283 HP and SAB 355 HP: 40 bar.

Design pressure for SAB 157 HR: 60 bar.

Min./max. speed	R717
SAB 157	1000-6000 rpm
SAB 193	1000-4200 rpm
SAB 233	1000-3800 rpm
SAB 283	1000-3600 rpm
SAB 355	1000-3600 rpm

Chillers based on SABROE core technologies

Chillers meet the demand for indirect cooling

Many industrial and commercial processes and installations require indirect rather than direct cooling. This is normally provided by special chiller units, in which a compressor cools a secondary refrigerant that then provides the desired cooling effect.

The use of secondary refrigerants – water, glycol, brine, etc. – is increasing rapidly because of the demand for safer installations and an intense, continuous focus on energy efficiency.

Another driver lies in both national and international legislation that requires phasing out particular refrigerants because of their environmental impacts.

Meeting the demand for chillers

SABROE therefore provides a range of energy-efficient standardised packaged chiller configurations, all based on high-efficiency SABROE reciprocating and screw compressors that are world-renowned for their reliability.

As a result, SABROE chillers are at the forefront of this rapidly developing specialist market.

Compliance

All SABROE chiller units are fully compliant with appropriate major international design codes and the specifications laid down by the most common classification societies. Approval in accordance with other technical requirements, specific national legislation or other classification societies' requirements is available on request.



SABROE chiller programme

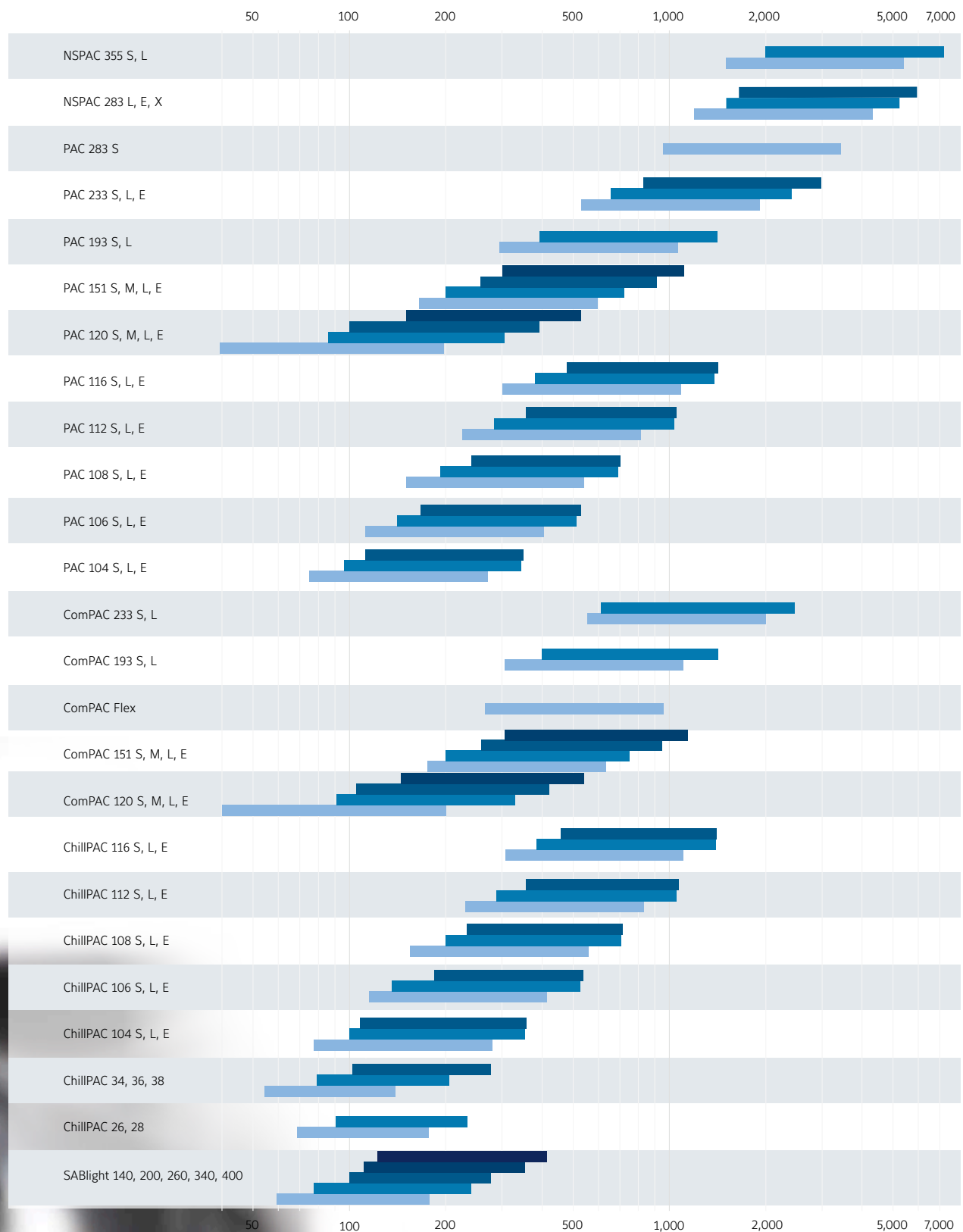

Capacities in kW at 7/12°C (cold side) and 30/35°C (hot side) in maximum speed (Reciprocating compressors at 50/60 Hz. Screw compressors at 50/60/70/100 Hz)

SABROE ChillPAC chillers

Extremely compact packaged ammonia chillers based on reciprocating compressors, with a 100–1400 kW capacity range

ChillPAC ammonia-based chillers feature an ultra-compact format so narrow that they can even pass through a normal doorway. This is achieved by having an extra-compact shell-and-plate evaporator/condenser, oil separator and control system all built in and fully integrated into a unique vibration-resistant design.

This means ChillPAC units provide exceptional refrigeration capacity – taking full advantage of the many different models of ultra-reliable SABROE reciprocating compressors – while only taking up a minimum of space. This makes ChillPAC units ideal in installations where space is limited, and where there are restrictions on the refrigerant charge used.

ChillPAC chillers are most cost-effective when fitted with a variable-speed drive (VSD) that makes it easy to deal with changing circumstances and different operating requirements.



ChillPAC 108 with VSD panel and Unisab III as standard

Range

There are 21 different models in the standard ChillPAC range, with capacities ranging from 90 kW to 1350 kW.

Advantages	Benefits
Factory-assembled, pre-tested packaged units based on SABROE reciprocating compressors world-renowned for their reliability	Easy pre-commissioning makes installation and running-in both faster and cheaper. Factory acceptance test (FAT) available (as an option)
Exceptionally compact design and fully integrated configuration result in less than half the footprint of bespoke chiller designs	Major savings on both weight and space, resulting in lower installation costs. Much less need for expensive separate machinery rooms
Indirect cooling and uncomplicated flooded evaporating system, using natural ammonia (R717) only	Greater safety and outstanding reliability
Exceptional COP and outstanding part-load performance	Greater cooling effect from a smaller refrigerant charge, and optimum load structure over the entire capacity range
Refrigerant charge 50% smaller than with conventional chillers, because of special condenser/evaporator design	Higher output per unit kW/kg refrigerant, lower unit cost and lower installation costs

Options

- Variable-speed drive (VSD)
- Soft-starter or Y/D starter
- Desuperheater
- Subcooler
- External condenser
- Control panel mounted separately
- S and L models: 1800 rpm at 60 Hz or VSD
- Factory acceptance test (FAT), customer-witnessed
- Heater package for low-temperature heat pump operation
- Shunt solution for high-temperature difference.

Water: inlet 12°C, outlet 7°C

Type	Cooling capacity	E-motor	R717 charge	Dry weight	Unit dimensions in mm			Sound level	SEPR
	kW	kW	kg	kg	L	W	H	dB(A)	
ChillPAC 24	117	29	10	2000	2900	1000	2000	72	11.58
ChillPAC 34	137	32	10	2000	2900	1000	2000	72	10.75
ChillPAC 26	176	39	12	2050	2900	1000	2000	72	10.50
ChillPAC 36	205	48	13	2100	2900	1000	2000	73	10.60
ChillPAC 28	233	48	14	2150	2900	1000	2000	73	10.61
ChillPAC 38	275	66	16	2900	2900	1000	2000	74	10.63
ChillPAC 104 S-A	273	66	15	2300	2900	1000	2000	80	9.33
ChillPAC 104 L-A	361	79	21	2410	2900	1000	2000	83	11.02
ChillPAC 104 E-A *	369	74	19	2652	2900	1000	2000	80	9.86
ChillPAC 106 S-A	406	91	20	2727	2900	1000	2000	83	9.67 **
ChillPAC 106 L-A	544	113	27	2950	2900	1000	2000	79	10.86
ChillPAC 106 E-A *	553	110	27	3225	3100	1000	2000	81	9.96
ChillPAC 108 S-A	573	113	28	3060	2900	1000	2000	84	10.64
ChillPAC 108 L-A	709	142	31	3526	3100	1000	2000	85	10.63
ChillPAC 108 E-A *	729	162	34	2880	3300	1000	2000	84	9.91
ChillPAC 112 S-A	851	177	40	4315	4000	1000	2200	86	10.39
ChillPAC 112 L-A	1055	200	46	4738	4500	1000	2200	86	10.45
ChillPAC 112 E-A *	1076	245	50	5196	4600	1000	2200	84	9.87
ChillPAC 116 S-A	1114	245	51	5044	4500	1000	2200	86	10.36
ChillPAC 116 L-A	1348	303	53	5556	4700	1000	2200	87	10.18
ChillPAC 116 E-A *	1350	290	53	5878	5000	1000	2200	85	9.30 **

Ethylene glycol 30%: inlet -2°C, outlet -8°C

Type	Cooling capacity	E-motor	R717 charge	Dry weight	Unit dimensions in mm			Sound level	SEPR
	kW	kW	kg	kg	L	W	H	dB(A)	
ChillPAC 24	61	22	10	2000	2900	1000	2000	73	5.44
ChillPAC 34	70	29	10	2000	2900	1000	2000	73	5.41
ChillPAC 26	87	30	10	2000	2900	1000	2000	73	5.37
ChillPAC 36	100	38	10	2050	2900	1000	2000	73	5.27
ChillPAC 28	114	46	11	2100	2900	1000	2000	74	5.24
ChillPAC 38	133	46	12	2250	2900	1000	2000	74	5.19
ChillPAC 104 S-C	140	54	13	2253	2900	1000	2000	78	5.21
ChillPAC 104 L-C	180	72	15	2378	2900	1000	2000	79	5.23
ChillPAC 104 E-C *	185	73	15	2586	2900	1000	2000	79	5.12
ChillPAC 106 S-C	208	72	16	2505	2900	1000	2000	80	5.20
ChillPAC 106 L-C	269	91	20	2701	2900	1000	2000	80	5.27
ChillPAC 106 E-C *	280	91	22	2866	2900	1000	2000	80	5.26
ChillPAC 108 S-C	280	91	22	2766	2900	1000	2000	82	5.36
ChillPAC 108 L-C	362	136	26	3091	3100	1000	2000	82	5.45 **
ChillPAC 108 E-C *	369	136	26	3523	3300	1000	2000	82	5.23
ChillPAC 112 S-C	419	136	32	3696	3800	1000	2200	83	5.38
ChillPAC 112 L-C	534	200	37	4290	4200	1000	2200	83	5.40
ChillPAC 112 E-C *	546	200	38	4733	4300	1000	2200	83	5.26
ChillPAC 116 S-C	547	200	38	4390	4200	1000	2200	83	5.38
ChillPAC 116 L-C	699	245	47	4898	4300	1000	2200	83	5.38
ChillPAC 116 E-C *	705	245	46	5322	4300	1000	2200	83	5.11

Condenser: water inlet 30°C, outlet 35°C.

The above data are only valid for the stated temperatures and operating conditions.

Capacities are nominal at 1800 rpm.

* Capacities are nominal at 1500 rpm.

** Unit used for letter of compliance for ECO-design.

Sound pressure levels in free field, over reflecting plane and one metre distance from the unit.

SEPR = Seasonal Energy Performance Ratio

CMO and SMC S and L models, 60 Hz or VSD operation possible.

Compliance

All SABROE chiller units are fully compliant with appropriate major international design codes and the specifications laid down by the most common classification societies. Approval in accordance with other technical requirements, specific national legislation or other classification societies' requirements is available on request.

All information is subject to change without notice.

SABROE ComPAC chillers

Packaged ammonia chillers based on screw compressors, with a 200–2200 kW capacity range

SABROE ComPAC ammonia chillers based on plate-and-shell heat exchangers and the comprehensive SABROE screw compressor programme (SAB 120-151 to SAB 193-233 and SABflex) are distinctive for their compactness. Frequency converter and panel solutions are supplied as standard.

As standard, ComPAC chillers use ultra-compact and extremely low-charge SABROE-patented plate-and-shell heat exchangers.

Range

There are 13 different standard models in this range of ComPAC chillers – both high- and low-temperature versions.

A comprehensive range of equipment options are available to ensure the best possible performance and application versatility.

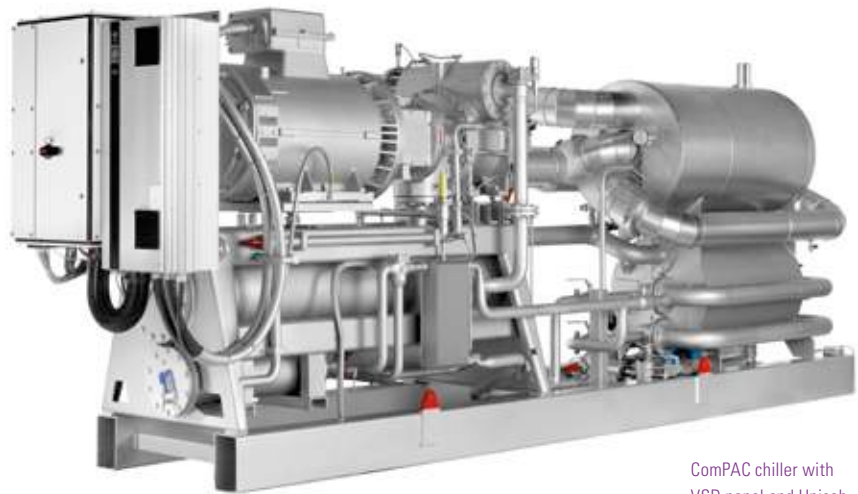

ComPAC chiller with VSD panel and Unisab III as standard

Advantages	Benefits
Factory-assembled, pre-tested packaged units based on renowned SABROE screw compressors	Easy pre-commissioning makes installation and running-in both faster and cheaper. Factory acceptance test (FAT) available (as an option)
Compact design with a very small footprint compared with bespoke chiller designs	Lower unit cost and lower installation costs
Indirect cooling and uncomplicated flooded evaporating system, using natural ammonia (R717) only	Major savings on both weight and space. Much less need for expensive separate machinery rooms
Exceptional COP and outstanding part-load performance	Greater safety and outstanding reliability
Small refrigerant charge, smaller than conventional chiller charges due to the special condenser/evaporator design	Greater cooling effect from a smaller refrigerant charge, and optimum load structure over the entire capacity range

Options

- Variable-speed drive (VSD)
- Soft-starter or Y/D starter
- Sound enclosure for outdoors mounting
- External condenser
- Control panel mounted separately
- Economiser option for low-temperature brine
- Factory acceptance test (FAT), customer-witnessed
- Heater package for low-temperature operation
- Shunt solution for high-temperature difference.

Water: inlet 12°C, outlet 7°C

Type	Cooling capacity kW	E-motor kW	R717 charge kg	Dry weight kg	Unit dimensions in mm			Sound level dB(A)	SEPR
					L	W	H		
ComPAC 120 S-A	190	55	21	3600	4600	1200	2300	85	6.99
ComPAC 120 M-A	316	78	26	3800	4700	1200	2300	86	7.40
ComPAC 120 L-A	401	97	29	4000	4800	1200	2300	87	7.62*
ComPAC 120 E-A	539	142	36	5200	5000	1200	2300	89	7.81
ComPAC 151 S-A	615	142	38	5500	5000	1200	2300	91	8.53
ComPAC 151 M-A	737	172	44	5800	5100	1200	2300	92	8.40
ComPAC 151 L-A	932	217	51	5900	5300	1200	2300	92	8.59
ComPAC Flex-A	950	315	54	5700	5500	1200	2300	89	8.01
ComPAC 151 E-A	1116	279	59	6300	5600	1200	2300	93	8.50
ComPAC 193 S-A	1067	222	57	7100	5600	1500	2400	85	9.51
ComPAC 193 L-A	1447	327	159	7400	6100	1500	2400	85	10.30*
ComPAC 233 S-A	1976	410	238	13000	7000	1500	2400	86	11.39
ComPAC 233 L-A	2305	536	297	15000	7100	1500	2400	86	9.34

Ethylene glycol 30%: inlet -2°C, outlet -8°C

Type	Cooling capacity kW	E-motor kW	R717 charge kg	Dry weight kg	Unit dimensions in mm			Sound level dB(A)	SEPR
					L	W	H		
ComPAC 120 S-C	109	45	21	3600	4500	1200	2300	85	4.03
ComPAC 120 M-C	177	78	26	3800	4600	1200	2300	86	4.38
ComPAC 120 L-C	224	93	29	4000	4700	1200	2300	87	4.45
ComPAC 120 E-C	297	114	36	5200	4900	1200	2300	89	4.51*
ComPAC 151 S-C	344	140	38	5500	4900	1200	2300	91	4.69
ComPAC 151 M-C	410	175	44	5800	5000	1200	2300	92	4.68
ComPAC 151 L-C	517	217	51	5900	5200	1200	2300	92	4.73
ComPAC Flex-C	541	200	54	5700	5400	1200	2300	89	4.64
ComPAC 151 E-C	620	269	59	6300	5500	1200	2300	93	4.77
ComPAC 193 S-C	597	217	57	7100	5500	1500	2400	85	4.95
ComPAC 193 L-C	798	279	71	7400	6000	1500	2400	85	4.91
ComPAC 233 S-C	1053	410	75	13000	6900	1500	2400	86	5.29
ComPAC 233 L-C	1362	472	225	15000	7000	1500	2400	86	5.34

Condenser: Water inlet 30°C, outlet 35°C.

All data and nominal capacities kW at 3600 rpm.

SABflex at 6000 rpm.

ComPAC 120 S at 1470 rpm.

* Unit used for letter of compliance for ECO-design.

Sound pressure levels in free field, over reflecting plane and one metre distance from the unit.

SEPR = Seasonal Energy Performance Ratio.

Available with high-pressure compressors as HeatPAC.

Compliance

All SABROE chiller units are fully compliant with appropriate major international design codes and the specifications laid down by the most common classification societies. Approval in accordance with other technical requirements, specific national legislation or other classification societies' requirements is available on request.

SABROE PAC chillers

Packaged ammonia chillers based on reciprocating compressors, with a 50–1400 kW capacity range

PAC ammonia-based chillers are fully integrated packaged units, designed to take full advantage of the many different models of ultra-reliable SABROE reciprocating compressors. They are popular because there is such a wide range of different standard sizes, and they are also particularly easy to customise to meet specific requirements.

The integrated design, with the plate evaporator/condenser, oil separator and control system all built in, means PAC units provide exceptional refrigeration capacity while only taking up a minimum of space. They are ideal for use in indirect cooling set-ups, and in installations where it is important to use future-compatible natural refrigerants, such as ammonia.

The advanced technology and the well-matched integration of the component systems make these chillers so energy efficient that their low operating costs make them the most economical choice over the lifetime of a refrigeration plant.

Range

There are 21 different standard models in this range of packaged chillers, with capacities ranging from 45 kW to 1419 kW.

Customised configurations are also available for use with remote air-cooled or evaporative condensers, and for twin or multi-packages, designed to provide particularly large cooling capacities.



PAC 116 chiller with Unisab III systems controller

Advantages	Benefits
Factory-assembled, pre-tested packaged units	Easy pre-commissioning makes installation and running-in both faster and cheaper. Factory acceptance test (FAT) available as an option
Comprehensive selection of compressor capacities, making it easier to match particular requirements	Avoid paying for greater capacity than needed
Very easy access for service	Improves safety, ensures maximum reliability and global sourcing of parts
Indirect cooling and uncomplicated flooded evaporating system, using natural ammonia (R717) only	Greater safety and outstanding reliability
Plate evaporator/condenser are easy to open and service	Routine checks/service can be carried out by operator's own staff

Options

- Variable-speed drive (VSD)
- Soft-starter or Y/D starter
- Desuperheater
- Subcooler
- External condenser
- Control panel mounted separately
- Factory acceptance test (FAT), customer-witnessed.

Water: inlet 12°C, outlet 7°C

Type	Capacity kW	E-motor kW	R717 charge kg	Dry weight kg	Unit dimensions in mm			Sound level dB(A)	SEPR
					L	W	H		
PAC 104 S-A	271	78	48	3100	3300	1850	2300	77	9.24
PAC 104 L-A	345	78	49	3250	3300	1850	2300	77	9.62
PAC 104 E-A *	351	91	51	3400	3300	1850	2300	78	9.14
PAC 106 S-A	406	91	51	3500	3300	1850	2300	78	9.56
PAC 106 L-A	517	113	54	3550	3300	1850	2300	79	10.08
PAC 106 E-A *	527	136	57	3700	3550	1850	2300	79	9.18
PAC 108 S-A	542	136	54	3700	3300	1850	2300	79	9.76
PAC 108 L-A	690	162	58	3900	3550	1850	2300	80	10.05
PAC 108 E-A *	702	162	74	4300	3850	1850	2450	80	9.26
PAC 112 S-A	812	200	73	4650	4130	1850	2450	80	9.67
PAC 112 L-A	1035	245	78	5000	4130	1850	2450	81	10.28
PAC 112 E-A *	1053	245	84	5300	4550	1850	2450	81	9.46
PAC 116 S-A	1083	245	79	5350	4130	1850	2450	81	10.04
PAC 116 L-A	1393	303	98	5650	4900	1850	2450	82	10.30
PAC 116 E-A *	1404	308	137	6300	5750	2000	2600	82	9.45

Ethylene glycol 30%: inlet -2°C, outlet -8°C

Type	Capacity kW	E-motor kW	R717 charge kg	Dry weight kg	Unit dimensions in mm			Sound level dB(A)	SEPR
					L	W	H		
PAC 104 S-C	130	48	47	3000	3300	1850	2300	76	4.79
PAC 104 L-C	171	78	48	3050	3300	1850	2300	77	4.89
PAC 104 E-C *	178	73	49	3200	3300	1850	2300	77	4.92
PAC 106 S-C	196	78	50	3250	3300	1850	2300	78	4.85
PAC 106 L-C	256	91	53	3450	3300	1850	2300	79	4.99
PAC 106 E-C *	266	91	54	3600	3300	1850	2300	79	4.98
PAC 108 S-C	261	91	53	3550	3300	1850	2300	79	4.97
PAC 108 L-C	342	136	57	3650	3300	1850	2300	80	5.04
PAC 108 E-C *	354	136	71	4100	3600	1850	2450	80	5.01
PAC 112 S-C	391	136	71	4400	4130	1850	2450	80	5.04
PAC 112 L-C	512	200	78	4600	4130	1850	2450	81	5.14
PAC 112 E-C *	530	200	79	5050	4130	1850	2450	81	4.99
PAC 116 S-C	522	200	77	5150	4130	1850	2450	81	5.08
PAC 116 L-C	684	245	86	5400	4130	1850	2450	82	5.14
PAC 116 E-C *	705	245	128	6000	4550	2000	2600	83	5.08

Condenser: water inlet 30°C, outlet 35°C.

The above data are only valid for the stated temperatures and operating conditions.

Capacities are nominal at 1800 rpm.

* Capacities are nominal at 1500 rpm.

PAC S and L models, 60 Hz or VSD operation possible.

Sound pressure levels in free field, over reflecting plane and one metre distance from the unit.

SEPR = Seasonal Energy Performance Ratio.

Available with high-pressure compressors as HeatPAC.

Compliance

All SABROE chiller units are fully compliant with appropriate major international design codes and the specifications laid down by the most common classification societies. Approval in accordance with other technical requirements, specific national legislation or other classification societies' requirements is available on request.

SABROE PAC chillers

Packaged ammonia chillers based on screw compressors, with a 100–6200 kW capacity range

PAC ammonia-based chillers are fully integrated packaged units, designed to take full advantage of the many different models of ultra-reliable SABROE screw compressors. They are popular because there is such a wide range of different standard sizes, and they are also particularly easy to customise to meet specific requirements.

The integrated design, with the plate evaporator/condenser, oil separator and control system all built in, means PAC units provide exceptional refrigeration capacity while only taking up a minimum of space. They are ideal for use in indirect cooling set-ups, and in installations where it is important to use future-compatible natural refrigerants, such as ammonia.

The advanced technology and the well-matched integration of the component systems make these chillers so energy efficient that their low operating costs make them the most economical choice over the lifetime of a refrigeration plant.

Range

There are 19 different standard models in this range of packaged chillers, with capacities ranging from approx. 109 kW to 6180 kW.

Customised configurations are also available for use with remote air-cooled or evaporative condensers, and for twin or multi-packages, designed to provide particularly large cooling capacities.

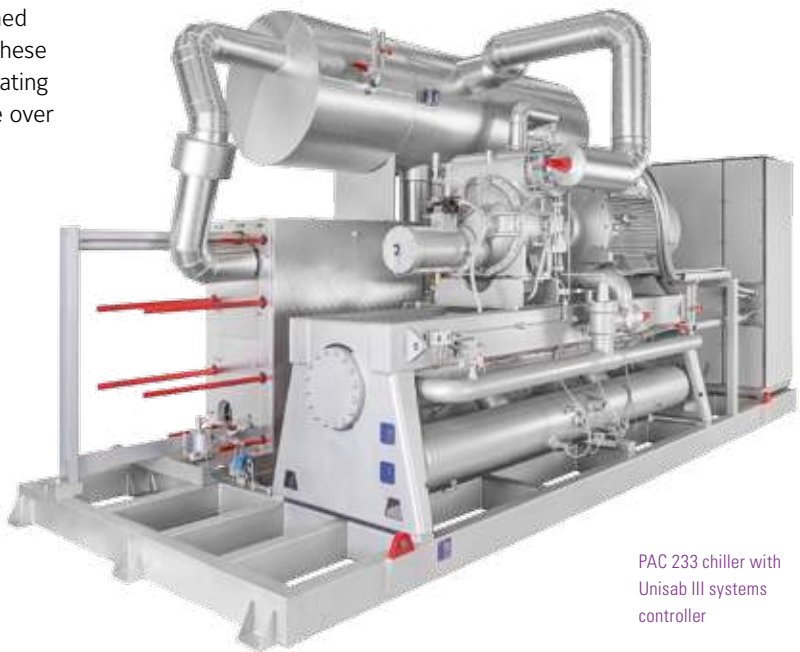

PAC 233 chiller with Unisab III systems controller

Advantages	Benefits
Factory-assembled, pre-tested packaged units	Easy pre-commissioning makes installation and running-in both faster and cheaper. Factory acceptance test (FAT) available as an option
Comprehensive selection of compressor capacities, making it easier to match particular requirements	Avoid paying for greater capacity than needed
Very easy access for service	Improves safety, ensures maximum reliability and global sourcing of parts
Indirect cooling and uncomplicated flooded evaporating system, using natural ammonia (R717) only	Greater safety and outstanding reliability
Plate evaporator/condenser are easy to open and service	Routine checks/service can be carried out by operator's own staff

Options

- Variable-speed drive (VSD)
- Soft-starter or Y/D starter
- Desuperheater
- Subcooler
- External condenser
- Control panel mounted separately
- 3600 rpm at 60 Hz or VSD
- 4200 rpm at 70 Hz or VSD (PAC 193, 233, 283, 355)
- Available with high-pressure compressors as HeatPAC
- Factory acceptance test (FAT), customer-witnessed.

Water: inlet 12°C, outlet 7°C

Type	Capacity kW	E-motor kW	R717 charge kg	Operational weight kg	Unit dimensions in mm			Sound level dB(A)	SEPR
					L	W	H		
PAC 120 S-A	195	55	38	4000	4310	1870	2260	82	6.79
PAC 120 M-A	253	75	40	4150	4310	1870	2260	83	7.15
PAC 120 L-A	324	75	50	4550	4310	1870	2260	84	7.37
PAC 120 E-A	439	110	54	4800	4560	1870	2360	86	7.57
PAC 151 S-A	509	132	55	5600	3800	2070	2360	88	8.22
PAC 151 M-A	594	160	59	5700	5700	2070	2360	89	8.09
PAC 151 L-A	755	200	75	6200	3940	2090	2450	89	8.29
PAC 193 S-A	865	200	81	6400	4600	2350	2450	82	8.54
PAC 151 E-A	914	200	80	6350	4600	2090	2450	90	8.34
PAC 193 L-A	1156	315	91	7000	5300	2350	2450	82	8.62
PAC 233 S-A	1571	355	167	11500	5500	2900	3200	83	9.38
PAC 233 L-A	2002	450	183	12500	6700	3000	3200	83	9.94
PAC 233 E-A	2479	560	211	15200	6700	3050	3400	84	10.51
PAC 283 S-A	2875	630	229	17000	7500	3400	3400	85	10.16
NSPAC 283 L-A	3596	800	350	20500	7300	3700	4500	83	
NSPAC 283 E-A	4367	900	391	25500	8500	3700	4700	83	
NSPAC 355 S-A	4516	1000	410	28000	8500	4000	4700	83	
NSPAC 283 X-A	4939	1000	450	30000	9100	4000	4700	83	
NSPAC 355 L-A	6180	1250	700	40000	10000	4000	6000	83	

Ethylene glycol 30%: inlet -2°C, outlet -8°C

Type	Capacity kW	E-motor kW	R717 charge kg	Operational weight kg	Unit dimensions in mm			Sound level dB(A)	SEPR
					L	W	H		
PAC 120 S-C	108	55	37	4000	4310	1870	2260	82	3.76
PAC 120 M-C	140	75	39	4150	4310	1870	2260	83	3.97
PAC 120 L-C	179	75	48	4500	4310	1870	2360	84	4.09
PAC 120 E-C	242	110	52	4700	4310	1870	2360	86	4.20
PAC 151 S-C	281	110	53	5550	3940	2070	2360	88	4.33
PAC 151 M-C	331	132	56	5600	3940	2070	2360	89	4.31
PAC 151 L-C	420	160	71	6100	3940	2090	2450	89	4.41
PAC 193 S-C	484	200	77	6250	4600	2350	2450	82	4.57
PAC 151 E-C	508	200	76	6200	4290	2090	2450	90	4.43
PAC 193 L-C	646	250	85	6750	5000	2350	2450	82	4.57
PAC 233 S-C	875	315	158	11250	5200	2750	3200	84	4.86
PAC 233 L-C	1102	400	170	12100	5800	2750	3200	84	4.87
PAC 233 E-C	1364	500	193	14700	6500	2800	3400	84	4.88
PAC 283 S-C	1587	560	206	16350	6700	3150	3400	86	4.89
PAC 283 L-C	1996	710	230	19000	7100	3700	3400	88	4.88
NSPAC 283 E-C	2412	900	374	24500	7300	3700	4500	84	
NSPAC 355 S-C	2525	900	380	26000	8000	4000	4700	84	
NSPAC 283 X-C	2752	1000	400	28000	8500	4000	4700	84	
NSPAC 355 L-C	3418	1200	600	38000	9500	4000	6000	84	

Condenser: water inlet 30°C, outlet 35°C.

The above data are only valid for the stated temperatures and operating conditions.

SEPR = Seasonal Energy Performance Ratio.

All data and nominal capacities kW at 3000 rpm.

60 Hz or VSD operation possible.

Sound pressure levels in free field, over reflecting plane and one metre distance from the unit.

Compliance

All SABROE chiller units are fully compliant with appropriate major international design codes and the specifications laid down by the most common classification societies.

Approval in accordance with other technical requirements, specific national legislation or other classification societies' requirements is available on request.

All information is subject to change without notice.

SABROE SABlight air-cooled chillers

Compact air-cooled chillers for outdoor installation, based on a screw compressor, with a 174–430 kW capacity range

The SABlight air-cooled chiller is a particularly compact design that uses V-coil condensers to substantially reduce the overall footprint. The screw compressor and fully brazed plate heat exchanger are mounted underneath the V-coils, resulting in a height of 2.9 m and a width of only 1.3 m.

SABlight units provide a cost-effective alternative to traditional air conditioning, chilled rooms and industrial/process refrigeration. They are designed for quiet running and outdoor operation, and a special ultra-low-noise version is available.

SABlight uses a small propane refrigerant charge, providing an attractive, economical and environmentally responsible alternative to air-cooled chillers that use HFCs as refrigerant.

Range

There are 5 standard models in this range of air-cooled chillers, with capacities ranging from 165 kW to 404 kW.



SABlight air-cooled chiller

Advantages	Benefits
Compact design with small footprint	Easy to mount outdoors – no special machinery room required
Quiet while running Available in both low and ultra-low noise versions	Can be placed close to occupied buildings
Variable-speed drive fitted to both compressor and fans, providing very high coefficient of performance (COP), even under part-load conditions	Low power consumption, which means low operating costs
Designed for maximum safety, with very small natural refrigerant charge (propane R290)	No expenditure on special safety precautions
Easy to mount, install and connect up	Low installation costs and rapid commissioning
Straightforward, uncomplicated construction	Low maintenance costs

Standard equipment

- Control and monitoring system
- Variable-speed drive
- Hot-dip galvanised base frame
- Screw compressor
- Precharged with refrigerant.

Options

- External communication via network and industrial-standard bus systems
- Evaporator heating elements for frost-proofing
- Epoxy coating of condenser surface
- Oil cooler
- Models operating with inlet temperatures down to -10°C available on request
- Desuperheater
- Condenser with air fresh-water spray system
- AxiTop diffuser on condenser fans for additional noise reduction.

Compliance

All SABlight air-cooled chillers are fully compliant with PED (CE marked and PED approved).

Approval in accordance with other classification societies is available on request.



SABlight air-cooled chiller

Technical data											SEPR
Capacities are nominal and based on water temperature 12/7°C, ambient temperature 35°C.											
Type	Cooling capacity kW	Power consumption kW	COP ESEER	R290 charge kg	Dry weight kg	Unit dimensions in mm			Nominal load current A	Sound level dB(A)	SEPR
						L	W	H			
SABlight A140-1	166	54	4.42	24	2300	5260	1250	2835	100	55	5.08
SABlight A140-2	163	55	4.63	24	2300	5260	1250	2835	105	45	5.49
SABlight A200-1	210	71	4.51	24	2500	5260	1250	2835	135	55	5.26
SABlight A200-2	208	71	4.48	32	3000	6660	1250	2835	140	45	5.47
SABlight A260-1	277	92	4.57	32	3000	6660	1250	2835	170	55	5.20
SABlight A260-2	274	94	4.52	40	3300	8060	1250	2835	170	45	5.39
SABlight A340-1	324	101	4.70	40	3700	8060	1250	2835	190	55	5.22
SABlight A340-2	314	106	4.55	48	4200	9460	1250	2915	195	45	5.49
SABlight A400-1	406	133	4.31	48	4600	9460	1250	2915	245	55	5.03 *
SABlight A400-2	390	140	4.15	56	5000	10860	1250	2915	250	45	4.95

* Unit used for letter of compliance for ECO-design.

Sound pressure levels in free field. All sound measuring has been carried out according to ISO 9614-2 at a distance of 10 m.

ESEER = European Seasonal Energy Efficiency Ratio (Eurovent Institute, Europe).

SEPR = Seasonal Energy Performance Ratio.

Fans and VSD are included in the power consumption.

All information is subject to change without notice.

SABROE CAFP CO₂/NH₃ low-temperature chiller

Compact packaged freezer systems using reciprocating compressors, and CO₂/NH₃ as refrigerant, with a 100–800 kW capacity range

The highly customised SABROE CAFP freezer systems are based on a cascade system that combines the advantages of CO₂ on the low-temperature side and ammonia on the high-temperature side.

These packaged systems are built around SABROE reciprocating compressors that use CO₂ as refrigerant, which gives them a significantly greater cooling capacity than corresponding compressors using ammonia. This in turn makes the low-temperature compressor much smaller, and the whole package significantly more compact than traditional two-stage ammonia-based freezer systems.

As a result, each standard CAFP package can be fitted inside a standard 20-foot shipping container, if required. This does away with the need for a special machinery space, and the freezer installation can easily be moved if required.

Compared with conventional ammonia-based two-stage or single-stage systems with economisers, a CAFP unit uses significantly less power in the temperature range down to -55°C.

This results in energy savings of as much as 15% compared with traditional two-stage ammonia systems, and up to 45% compared with single-stage set-ups.



CAFP unit controlled and monitored by Unisab III systems controller

Advantages	Benefits
Compact design that fits inside a standard 20-foot container	Big savings on installation costs
High COP and extremely low power consumption, even at part load	Low operating costs
Use of CO ₂ as low-temperature refrigerant reduces piping complexity and costs	Reduces installation costs
Very small ammonia charge, located on the unit itself	No risk of ammonia leaks in production areas, cold stores and working areas
CO ₂ is a simple, inexpensive natural refrigerant	Low operating costs

Range

There are 6 standard models in this range of freezer systems, with capacities ranging from 87 kW to 793 kW.

All CAFP units are operationally tested with refrigerant before dispatch. Factory acceptance test (FAT) available.

Standard equipment

- Double control panel including Unisab III systems controller
- CO₂ pump separator including two pumps (one standby)
- Shell-and-tube cascade cooler with double-tube sheet to minimise any risk of CO₂ and ammonia mixing
- Standstill cooling unit, with separate control panel and power supply, to limit CO₂ pressure
- Automatic oil recovery system in both circuits
- Water-cooled condenser (plate heat exchanger type) on ammonia side
- Insulation of all cold parts.

Options

- Variable-speed drive
- Titanium plates in condenser
- Oversized CO₂ pump separator for high CO₂ evaporator volume
- Oversized CO₂ pumps for higher circulation rate
- Oversized ammonia condenser for higher cooling water temperature
- Fully welded shell-and-tube cascade cooler
- External interstage load, including a brine cooler on the R717 side of the cascade cooler
- Special version for use with remote condenser
- Configurations for use with HCFC refrigerants instead of ammonia on high-pressure side.

Compliance

All SABROE chiller units are fully compliant with appropriate major international design codes and the specifications laid down by the most common classification societies.

Approval in accordance with other technical requirements, specific national legislation or other classification societies' requirements is available on request.

Model	Evaporation temperature °C	Capacity kW	Power consumption kW	Compressors R744/R717	Minimum NH ₃ charge kg (approx.)	Minimum CO ₂ charge l (approx.)	Unit dimensions in mm (approx.) L x W x H	Weight (approx.) kg	Sound pressure level dB(A)
CAFP 80	-50	87	64	HPO 24 / SMC 104 S					78
CAFP 80	-45	112	74	HPO 24 / SMC 104 L					80
CAFP 80	-40	127	84	HPO 24 / SMC 104 E	120	300	5500 x 2400 x 3000	7000	79
CAFP 80	-35	144	82	HPO 24 / SMC 106 S					79
CAFP 120	-50	131	94	HPO 26 / SMC 106 S					80
CAFP 120	-45	169	110	HPO 26 / SMC 106 L					80
CAFP 120	-40	217	126	HPO 26 / SMC 106 E	120	350	5700 x 3200 x 3300	10000	80
CAFP 120	-35	264	137	HPO 26 / SMC 108 L					82
CAFP 160	-50	174	125	HPO 28 / SMC 108 S					80
CAFP 160	-45	223	147	HPO 28 / SMC 108 L					82
CAFP 160	-40	288	167	HPO 28 / SMC 108 E	120	350	5900 x 2900 x 3300	11000	82
CAFP 160	-35	363	188	HPO 28 / SMC 112 L					83
CAFP 200	-50	211	150	HPC 104 / SMC 106 E					80
CAFP 200	-45	277	177	HPC 104 / SMC 108 E					82
CAFP 200	-40	353	200	HPC 104 / SMC 112 L	180	350	5900 x 3100 x 3800	14000	82
CAFP 200	-35	415	214	HPC 104 / SMC 112 L					83
CAFP 300	-50	324	228	HPC 106 / SMC 112 L					82
CAFP 300	-45	416	263	HPC 106 / SMC 112 E					82
CAFP 300	-40	511	290	HPC 106 / SMC 116 L	300	800	6300 x 3200 x 3900	16000	83
CAFP 300	-35	599	310	HPC 106 / SMC 116 L					83
CAFP 400	-50	421	296	HPC 108 / SMC 112 E					82
CAFP 400	-45	520	332	HPC 108 / SMC 116 L					83
CAFP 400	-40	667	375	HPC 108 / SMC 116 E	400	800	6500 x 3700 x 4000	19000	83
CAFP 400	-35	793	398	HPC 108 / SMC 116 E					83

Condenser: water inlet 25°C, outlet 30°C.
Capacities are nominal, 1500 rpm at 50 Hz.
Power consumption applies to compressors only.
Refrigerant charge depends on application.

Dry weight (approx.).
Sound pressure levels in free field, over reflecting plane and one metre distance from the unit.

All information is subject to change without notice.

Heat pumps based on SABROE core technologies

Heat pump pioneer

SABROE is one of the world's leading suppliers of heat pump systems for commercial and industrial use. We were one of the pioneers of the whole idea of the energy benefits to be reaped from using heat pumps in industry – long before they became greentech-fashionable.

SABROE HeatPAC heat pumps are the ideal solution for effectively exploiting low-temperature waste heat, and turning it into hot water (up to 90°C), using only a minimum of electrical energy.

Ammonia as refrigerant

SABROE industrial heat pumps use natural ammonia (R717) as refrigerant. Each unit is customised for the specific use and the particular installation, making sure that a minimum of thermal energy is used to provide maximum effect.



Customised two-stage
heat pump

SABROE heat pump programme

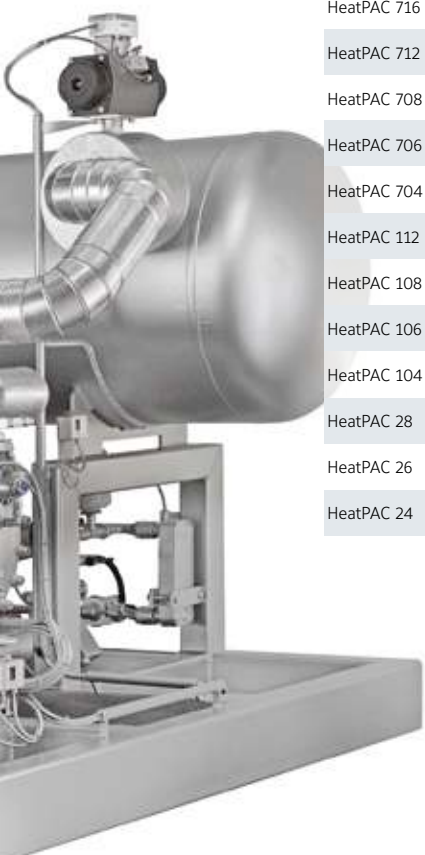
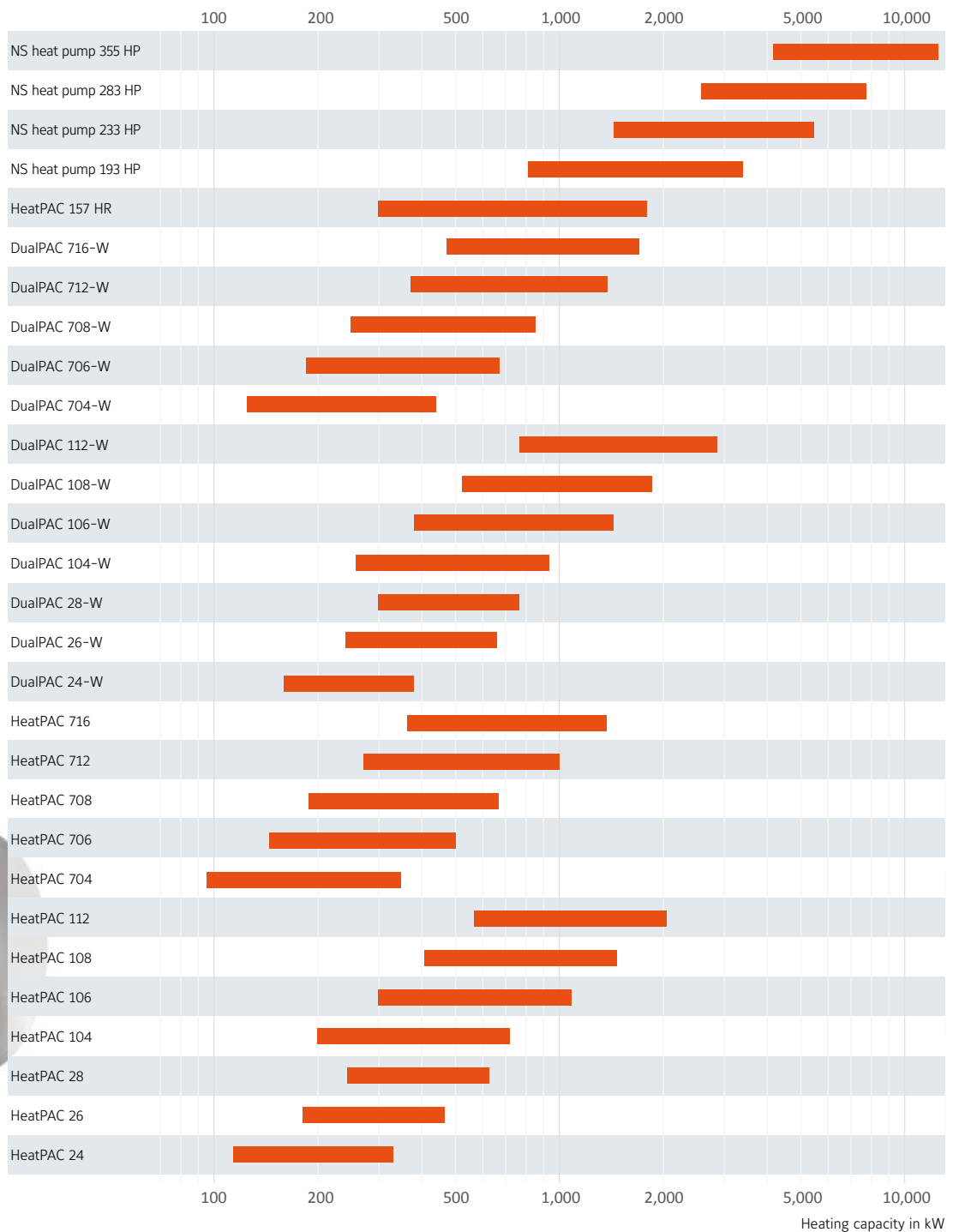

Heat pumps

SABROE HeatPAC heat pumps

Ammonia-based heat pumps using a reciprocating compressor, with a 300–2000 kW capacity range

HeatPAC units are extremely compact heat pumps based on ultra-reliable SABROE HPO/ HPC high-pressure reciprocating compressors, using ammonia as refrigerant. They are usually most cost-effective when fitted with a variable-speed drive (VSD) that makes it easy to deal with changing circumstances and different operating requirements. These highly customisable integrated units are based on a unique vibration-resistant design, featuring an uncomplicated flooded evaporating system. They provide exceptional heat pump capacity from the smallest possible footprint, and with only a very small refrigerant charge.

SABROE HeatPAC heat pumps are the ideal solution for effectively exploiting low-temperature waste heat, and turning it into hot water (up to 75°C), using only a minimum of electrical energy. These units are designed to provide a cost-effective way to tackle needs for cooling and heating at the same time, providing an extremely high coefficient of performance (COP).



HeatPAC 108 with panel-mounted Unisab III systems controller

Range

There are 7 standard models in this range of heat pump systems, with capacities ranging from 310 kW to 2075 kW.

Advantages	Benefits
Factory-assembled, pre-tested packaged units based on SABROE reciprocating compressors world-renowned for their reliability	Easy pre-commissioning makes installation and running-in both faster and cheaper
Integrated configuration weighs less, and has less than half the footprint of bespoke heat pump designs	Low installation costs. Easy to mount even in confined spaces or unconventional locations
Indirect cooling and an uncomplicated flooded evaporating system, using natural ammonia (R717) only	Greater safety and outstanding reliability
Exceptional COP and outstanding part-load performance	Low operating costs
Refrigerant charge 50% smaller than with conventional heat pumps, because of special condenser/evaporator design	Higher output per unit kW/kg refrigerant, lower unit cost and lower installation costs

Options

- Cascade evaporator
- Variable-speed drive (VSD)
- Soft-starter or Y/D starter
- Desuperheater
- Subcooler
- Control panel mounted separately
- Factory acceptance test (FAT), customer-witnessed.

Compliance

All HeatPAC heat pumps are fully compliant with appropriate major international design codes and the specifications laid down by the most common classification societies.

Approval in accordance with other technical requirements, specific national legislation or other classification societies' requirements is available on request.



Unisab control for heat pump application

Condenser water inlet +60°C, outlet +70°C
Evaporator water inlet +39°C, outlet +34°C

Type	Heating capacity kW	Cooling capacity kW	Line power consumption kW	COP line heat	R717 charge kg	Dry weight kg	Unit dimensions in mm			Sound level dB(A)
							L	W	H	
HeatPAC 24-W	310	263	50	6.1	29	2020	2800	1000	2000	75
HeatPAC 26-W	465	395	76	6.1	38	2230	2850	1000	2000	76
HeatPAC 28-W	620	527	101	6.1	48	2420	2900	1000	2000	77
HeatPAC 104-W	731	618	120	6.1	55	2630	3050	1000	2000	81
HeatPAC 106-W	1081	911	180	6.0	74	3300	3750	1000	2000	82
HeatPAC 108-W	1441	1216	239	6.0	87	3950	4050	1000	2000	83
HeatPAC 112-W	2075	1735	345	6.0	110	5270	5050	1000	2100	85

W = Heat pump unit water/water.

All data and nominal capacities kW at 1800 rpm.

All HeatPACs: 60 Hz or VSD operation possible.

Sound pressure levels in free field, over reflecting plane and one metre distance from the unit.

SABROE DualPAC heat pumps

Two-stage ammonia-based heat pumps with capacities of up to 2500 kW

SABROE DualPAC heat pumps combine ChillPAC, HeatPAC and HeatPAC HPX units into one single heat pump, using an ingenious modular system that makes it possible to achieve high temperature lifts, with the advantages of compact design and attractive operating economics.

The DualPAC is a two-stage high-temperature heat pump configuration that uses ammonia as refrigerant, and is designed with the sole aim of best possible performance and versatile operating conditions along with the same practical benefits – including small refrigerant charges and limited footprint – as any other SABROE heat pump. This unique setup ensures maximum flexibility in both configuration and capabilities, because all standard ChillPAC and HeatPAC models can be used.

The setup is possible due to a purpose-designed open inter-stage cooler that operates with a minimal refrigerant charge.

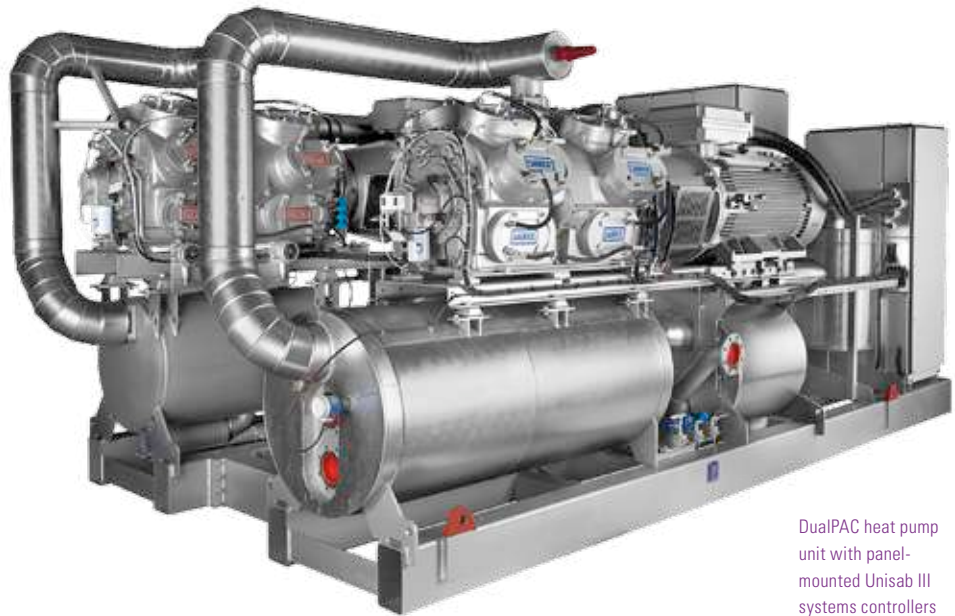

DualPAC heat pump unit with panel-mounted Unisab III systems controllers

Advantages	Benefits
Stepless, skip-free capacity control ensures that output always matches requirements	Lowest possible operating costs and maximum return on investment
Consistently high performance at both full and part load	Maximum part-load efficiency and low life cycle costs
Unique two-stage solution featuring patented technology	Makes it possible to deal with multiple sets of running conditions
Space-saving footprint, with fewer moving parts and very low vibration	Exceptional reliability and low maintenance costs
Supports Condition Based Service (CBS) schedules	Optimised service/maintenance intervals, with a minimum of unscheduled downtime

The DualPAC benefits from all of the advantages of the ChillPAC and HeatPAC product ranges, based on patented SABROE evaporator and condenser designs along with the most extensive range of reciprocating compressors available anywhere in the world, and featuring configurations with HPO/ HPC or HPX compressors as the high stage and SMC compressors on the low stage.

Within the extensive portfolio of SABROE heat pumps, these dual versions are ideal wherever there is a need for big temperature lifts along with good performance in order to make the installation financially advantageous.

The DualPAC configuration is optimised for use in district heating and ground-source cooling, so that thermal energy can be put to the most cost-effective use. The water circuit on the hot side consists of a series of heat exchangers built into one single vessel that extracts the heat from de-superheating, condensing and subcooling processes. In many cases even de-superheating at the low stage is profitable, and serves to increase performance still further.

Condenser: water inlet: 50°C, outlet 70°C

Evaporator: water inlet 30°C, outlet 20°C

Type	Heating capacity kW	Cooling capacity kW	Power consumption kW (shaft)	COP heat (shaft)	R717 charge	Dry weight kg (approx.)	Unit dimensions in mm (approx.)			Sound level dB(A)
							L	W	H	
DualPAC 24-W	387	312	75	5.1	35	4020	2900	3000	2000	82
DualPAC 26-W	581	455	115	5.0	40	4460	2900	3000	2000	83
DualPAC 28-W	775	619	155	4.9	45	4840	2900	3000	2000	84
DualPAC 104-W	935	745	189	4.9	65	5500	4500	3000	2000	84
DualPAC 106-W	1388	1109	282	4.9	70	6700	5000	3000	2000	85
DualPAC 108-W	1850	1471	379	4.8	95	7890	6000	3000	2200	86
DualPAC 112-W	2777	2190	584	4.7	115	10450	7500	3000	2200	86
DualPAC 704-W	435	348	86	5.0	40	6500	3500	3000	2100	86
DualPAC 706-W	652	520	132	4.9	45	7900	3700	3000	2100	86
DualPAC 708-W	870	690	180	4.8	55	10000	4100	3000	2100	87
DualPAC 712-W	1305	1025	280	4.6	75	13500	5000	3000	2100	88
DualPAC 716-W	1740	1365	375	3.6	115	16500	6000	3000	2100	89

Heat pumps

Condenser: water inlet: 70°C, outlet 90°C

Evaporator: water inlet 15°C, outlet 5°C

Type	Heating capacity kW	Cooling capacity kW	Power consumption kW (shaft)	COP heat (shaft)	R717 charge	Dry weight kg	Unit dimensions in mm (approx.)			Sound level dB(A)
							L	W	H	
DualPAC 704-W	444	308	140	3.1	40	6500	3500	3000	2100	86
DualPAC 706-W	666	460	212	3.3	45	7900	3700	3000	2100	86
DualPAC 708-W	888	610	287	3.0	55	10000	4100	3000	2100	87
DualPAC 712-W	1332	907	441	3.0	75	13500	5000	3000	2100	88
DualPAC 716-W	1775	1205	595	2.9	115	16500	6000	3000	2100	89

Please contact your SABROE representative for availability.

All information is subject to change without notice.

SABROE HeatPAC HPX heat pumps

Single-stage high-pressure ammonia-based heat pumps, using a reciprocating compressor, with a 326–1300 kW capacity range

SABROE HeatPAC HPX heat pumps are compact units with an integrated single-stage configuration that features less than half the space and weight requirements of any other heat pump designs usually needed to achieve 90°C hot water outputs.

These energy-efficient units feature a breakthrough HPX hybrid compressor design that allows differential pressures as high as 40 bar and discharge pressures as high as 60 bar, combined with space-saving evaporator technology from the ChillPAC packaged ammonia chiller.

HeatPAC HPX heat pumps make it easy to produce hot water at temperatures up to 90°C, using any suitable source of low-temperature heat, with only tiny energy inputs needed.

They provide a low-cost supply of hot water at temperatures ideal for sterilisation and pasteurisation – as well as many other hygiene-sensitive functions and processes.



HeatPAC HPX with panel-mounted Unisab III systems controller

Advantages	Benefits
Factory-assembled, pre-commissioned units based on ultra-reliable SABROE reciprocating compressors	Easy, rapid commissioning saves time money and manpower, and minimises disruption
Compact single-stage configuration weighs less and takes up less space than bespoke and/or two-stage heat pump designs	Easy to mount or retrofit, even in confined spaces or unconventional locations
Exceptional Coefficient of Performance (COP) in high-temperature single-stage configuration	High energy-efficiency, low operating costs
Variable-speed drive (VSD) and Unisab III compressor package controller as standard	Outstanding part-load performance and maximum operating flexibility
Service and maintenance based on Load Based Service (LBS) schedules	Improved reliability, longer service intervals, minimal downtime, low cost of ownership

Options

- Cascade evaporator
- Subcooler
- Control panel mounted separately
- Factory acceptance test (FAT), customer-witnessed.

Compliance

HeatPAC HPX heat pumps are fully compliant with appropriate major international design codes and the specifications laid down by the most common classification societies.

Approval in accordance with other technical requirements, specific national legislation or other classification societies' requirements is available on request.

HeatPAC HPX with panel-mounted Unisab III systems controller

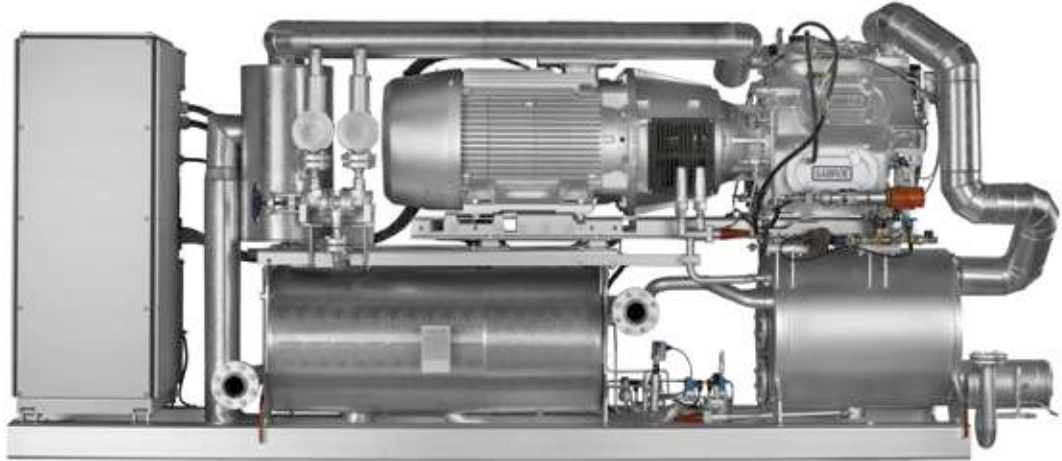

Condenser water inlet +70°C, outlet +90°C
Evaporator water inlet +39°C, outlet +34°C

Type	Heating capacity kW	Cooling capacity kW	E-motor kW	COP line heat	R717 charge kg	Dry weight kg	Unit dimensions in mm			Sound level dB(A)
							L	W	H	
HeatPAC 704-W	338.7	266.7	91	4.2	19	3500	3500	1000	2100	83
HeatPAC 706-W	508.1	400.2	136	4.2	29	4200	3700	1000	2100	85
HeatPAC 708-W	677.5	533.6	200	4.2	35	5000	4100	1000	2100	86
HeatPAC 712-W	1016	800.6	303	4.2	55	6250	4700	1000	2100	87
HeatPAC 716-W	1355	1067	345	4.2	75	7000	6000	1000	2100	88

W = Heat pump unit water/water.
 Capacities are nominal at 1800 rpm.
 VSD drive is standard.

Sound pressure levels in free field, over reflecting plane and one metre distance from the unit.

SABROE heat pumps

Ammonia-based heat pumps using a screw compressor, with a capacity of up to 1800 kW

SABROE heat pumps are extremely compact units based on ultra-reliable SABROE high-pressure screw compressors, using ammonia as refrigerant.

These highly customisable integrated units, featuring an uncomplicated flooded evaporating system, provide exceptional heat pump capacity from the smallest possible footprint, and with only a very small refrigerant charge. They are designed to provide a cost-effective way to tackle needs for cooling and heating at the same time, providing an extremely high coefficient of performance (COP).

SABROE heat pumps are the ideal solution for effectively exploiting low-temperature waste heat, and turning it into hot water (up to 90°C), using only a minimum of electrical energy.

SABROE heat pumps provide considerable scope for customisation to meet specific customer requirements.

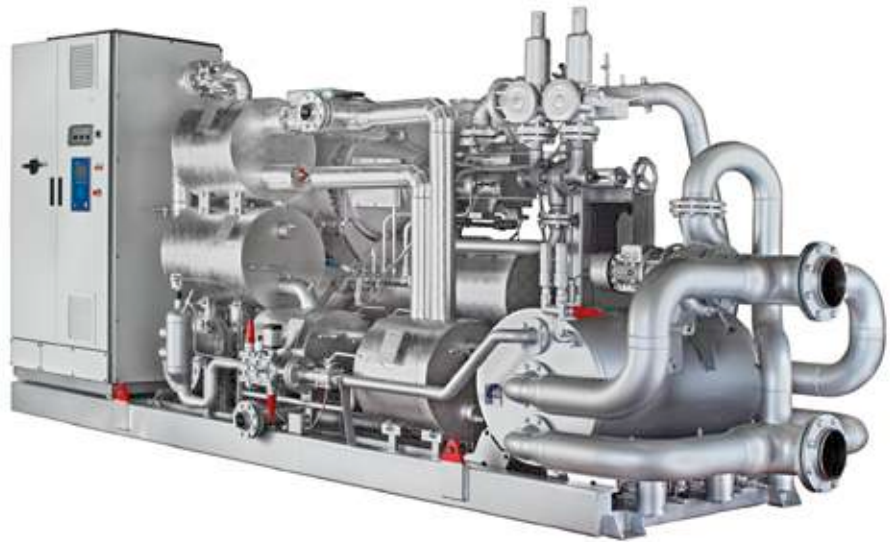

Heat pump with panel-mounted Unisab III systems controller

Advantages	Benefits
Factory-assembled, pre-tested packaged units based on SABROE screw compressors world-renowned for their reliability	Easy pre-commissioning makes installation and running-in both faster and cheaper. Factory acceptance test (FAT) available as an option
Integrated configuration weighs less, and has less than half the footprint of bespoke heat pump designs	Low installation costs Easy to mount even in confined spaces or unconventional locations
Indirect cooling and an uncomplicated flooded evaporating system, using natural ammonia (R717) only	Greater safety and outstanding reliability
Exceptional COP and outstanding part-load performance	Low operating costs
Refrigerant charge 50% smaller than with conventional heat pumps, because of special condenser/evaporator design	Higher output per unit kW/kg refrigerant, lower unit cost and lower installation costs

Options

- Cascade evaporator
- Control panel mounted separately
- Factory acceptance test (FAT), customer-witnessed.

Compliance

All SABROE heat pumps are fully compliant with appropriate major international design codes and the specifications laid down by the most common classification societies.

Approval in accordance with other technical requirements, specific national legislation or other classification societies' requirements is available on request.

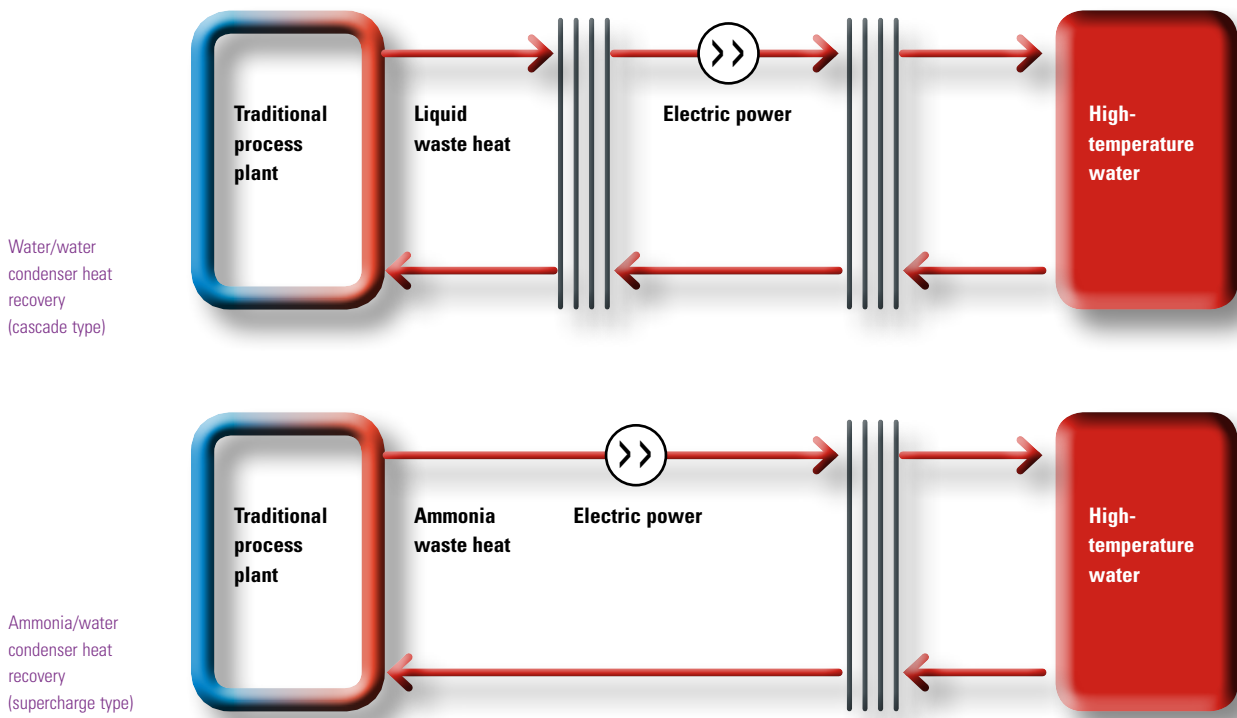

A SABROE heat pump can cope with a wide range of operating conditions. These units are particularly efficient under part-load conditions due to the variable speed drive (1000–6000 rpm) fitted as standard.

Each unit is specially configured to comply with the specific set of operating conditions, in order to ensure the most effective exploitation of the waste heat available.

Heat pumps											
	Cold side				Hot side					Power motor kW	COP
	Temperature in °C	Temperature out °C	Flow m ³ /h	Cooling capacity kW	Temperature in °C	Temperature out °C	Flow m ³ /h	Heating capacity kW			
Water	40	35.9	300	1422	Water	40	85	34.8	1792	407	4.4
Water	30	26.8	300	1107	Water	40	85	28.2	1453	381	3.8
Water	20	17.6	300	818	Water	40	85	22.0	1121	335	3.3
Water	10	8.3	300	588	Water	40	85	16.5	852	290	2.9

Capacities are nominal at 6000 rpm. Specific capacity must be calculated for actual running conditions. Available on request.

SABROE customised heat pumps

Ammonia-based heat pumps using a screw compressor with capacities of up to 13000 kW

SABROE provides customised large-capacity heat pumps for reclaiming waste heat or supporting industrial processes that require both heating and cooling at the same time. These highly effective heat pumps, utilising the economiser technology of screw compressors, ensure very high performance and exceptional reliability as well as the cost-effective exploitation of a key heat source in industry – waste heat from other processes.

These extremely large non-standard heat pumps can be configured with single, twin or even triple heat exchangers and compressors to provide capacities extending as high as 13000 kW.

The backbone for all this is the unique high-pressure version of SAB screw compressors, featuring casings made of ductile iron, ensuring exceptional reliability and long service life. Individually configured units focus on meeting specific operating requirements, and the wide range of options makes it possible to achieve a considerable effect on operating margins in heating solutions.

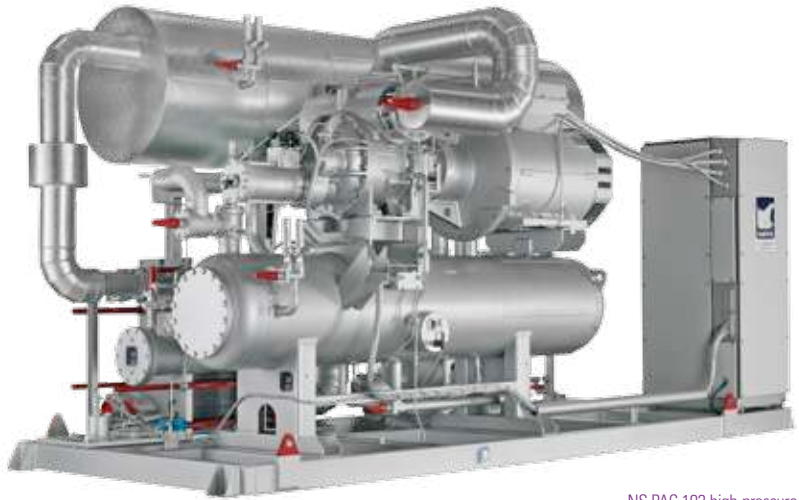

NS PAC 193 high-pressure heat pump with panel-mounted Unisab III systems controller

The design incorporates the most appropriate selection of heat exchanger technology in order to provide the best possible match for a wide range of running conditions, performance requirements, fouling challenges and specifications for mechanical robustness. This results in a long, profitable service life with a cost-saving minimum of service and maintenance.

Advantages	Benefits
Factory-assembled, pre-tested packaged units	Easy pre-commissioning makes installation and running-in both faster and cheaper
Capacity test that ensures high performance at both full and part load	Maximum part-load efficiency and low life cycle costs
Supreme high-pressure units designed specifically for ammonia with strong legacy in the market	Makes it possible to utilise waste heat as an effective alternative heat source
Small, space-saving footprint, with fewer moving parts and very low vibration	Exceptional reliability and low maintenance costs, as well as very easy access for service
Supports Condition Based Service (CBS) schedules, which help improve safety and ensure maximum reliability	Optimised service/maintenance intervals, with a minimum of unscheduled downtime

Options

- Two-stage units
- Modular design for easy transport and rapid on-site assembly
- Shell-and-plate heat exchangers
- Shell-and-tube heat exchangers
- Parallel heat exchanger operation
- Variable-speed drive
- Soft-starter or Y/D starter
- High-voltage motors
- Complete economiser systems
- Sensors and transmitters for control by external PLC systems
- Customer-witnessed factory acceptance test (FAT).

All SABROE heat pumps are designed to make clear business sense when in operation. Large SABROE heat pumps – even single-stage high-lift units fitted with an economiser – deliver the performance needed for effective interaction with boiler systems or modern district heating systems.

The design paves the way for running modes in which the heat pump is used either as a parallel supplier to the boiler or in series to optimise performance, thus optimising operating conditions so that SABROE heat pumps can reclaim waste heat effectively under different conditions over the course of the year, and thus provide maximum return on investment.

Condenser water inlet +60°C, outlet 70°C
Evaporator water inlet +10°C, outlet 6°C

Model	Max. rpm	Capacities in kW at +4/72°C R717					Sound pressure level dB(A)
		Cooling	Heating	Power consumption	COP _{line} heating	COP _{line} cooling	
NS heat pump 193 HP	4200	1270	1797	527	3.41	2.41	84
NS heat pump 233 HP	3800	2040	2866	826	3.47	2.47	86
NS heat pump 283 HP	3000	2895	4063	1168	3.48	2.48	88
NS heat pump 355 HP	3000	4640	6517	1877	3.47	2.47	89

Condenser water inlet +60°C, outlet 70°C
Evaporator water inlet +40°C, outlet 34°C

Model	Max. rpm	Capacities in kW at +32/72°C R717					Sound pressure level dB(A)
		Cooling	Heating	Power consumption	COP _{line} heating	COP _{line} cooling	
NS heat pump 193 HP	4200	2822	3399	577	5.90	4.90	84
NS heat pump 233 HP	3800	4576	5466	890	6.15	5.15	86
NS heat pump 283 HP	3000	6492	7744	1252	6.19	5.19	88
NS heat pump 355 HP	3000	10453	12491	2038	6.13	5.13	89

All capacities include economiser operation.
Design pressure for SAB 193 HP, SAB 233 HP, SAB 283 HP and SAB 355 HP: 40 bar.

Dimensions on request.

Non-standard SABROE heat pumps are available on request.

SABROE control systems



Control systems for every requirement

Matching operations to conditions

One of the most effective ways to improve the overall efficiency of your refrigeration setup is to make sure your processes and operations are always in tune with constantly changing operating parameters and equipment status, as well as unpredictable weather and climate conditions.

SABROE control solutions and monitoring systems combine to leverage the effectiveness and operational reliability of all kinds of HVACR systems, as well as the efficiency of the industrial processes of which they are a part.

SABROE digital monitoring and data management technologies make it easy to harvest, collate and apply operating data on all levels, right from local equipment conditions to high-level operational status and analysis reports.

These systems enable you to take fully informed decisions when dealing with changes in – and changes to – operating conditions. Reliable, easy-to-use data helps you improve the energy efficiency of your operations, reduce your operating costs and boost your return on investment.

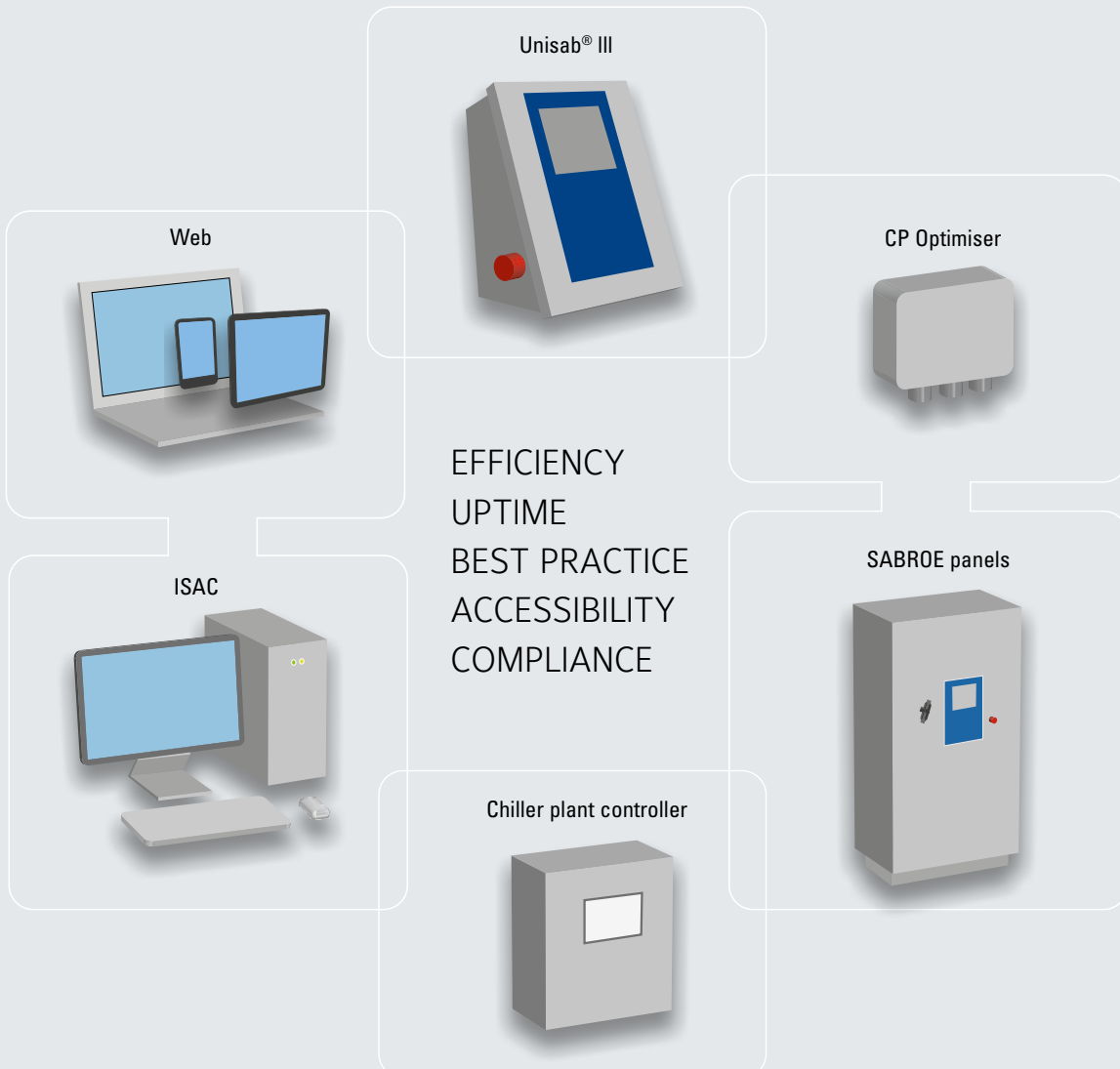

SABROE Unisab III

Integrated systems controller for refrigeration compressors, chillers and heat pumps

Unisab III systems controllers are connectivity hubs that help make sure refrigeration installations have the best possible performance, maximum uptime and lowest possible operating costs.

These important control units are pre-equipped and pre-configured with the connectivity equipment and protocols necessary for monitoring and controlling a wide range of compressors, compressor packages, chillers and heat pumps – as well as using this data for fault-finding and analysis.

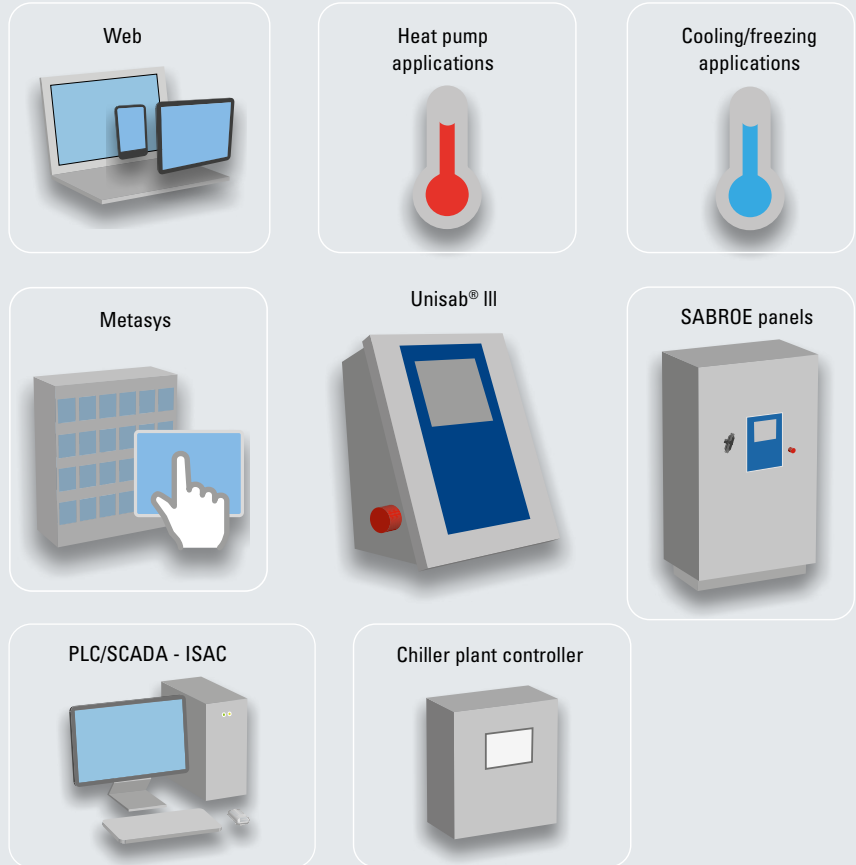

Advantages	Benefits
Single, fully integrated control system for use with virtually all types of compressors and chillers	Ensures more effective monitoring, control and diagnostics of a wide range of key refrigeration installations
Easy to integrate into the vast majority of industrial control systems, providing seamless transfer of data between systems	Ensures effective management of important operating data and secures the production process for best performance
Monitoring, control and diagnostics capabilities combined in one compact, integrated unit	Does away with the need for multiple systems, resulting in significant equipment savings
Compressor sequencing and load sharing are possible without additional equipment	Keeps power consumption to a minimum and reduces operating costs
Intuitive, easy-to-use interface, with a consistent “look and feel”	Requires fewer operator skills, resulting in lower training costs



Unisab Event app available for both iOS and Android devices

Connectivity

The Unisab III systems controller has normal industry-standard communication ports fitted as standard, and therefore does not require additional communication gateways.

Data can then be made available via any kind of network, where virtually any computer can be used to monitor and operate the Unisab III systems controller.

Functionality

- Service on demand schedule
- Unisab app for smartphone
- Configurable for both screw compressors and reciprocating compressors, with or without variable-speed drive (VSD), and using any refrigerant
- Built-in regulation of suction pressure, water temperature, discharge pressure, etc.
- Limitations on suction pressure, discharge pressure, motor current, etc.
- Logging of operating history and profiles for effective fault-finding and diagnosis
- Email dispatch in case of alarm or shut down.

Retrofit

A wide range of Unisab III retrofit kits are available to provide all the advantages of upgrading a wide range of existing compressors to a modern controls standard for improved performance and control system integration.

Retrofit kits are available for the full legacy of SABROE, Frick and Stal compressors – and most competitor compressors.



Connectivity	Multiple communication ports, including Modbus TCP, Profibus DP and Sequence Bus, as standard
Smartphone app	Available for both iOS and Android devices
Sequencing.	As many as 14 refrigeration compressors (per temperature or pressure system), chillers and heat pumps of different makes and types can be linked in sequence, to ensure effective load sharing and capacity optimisation
Diagnostics.	Detailed operating data documenting 30 shutdown situations
Refrigerants	Pre-loaded with the requisite data about all refrigerants normally used
Operating languages	Multiple languages available as standard, with additional languages as options
Enclosure.	IP54
Ambient temperature	0–55°C
Power supply.	85–250 volt AC, 50–60 Hz
Dimensions (H x W x D)	380 x 300 x 210 mm
Weight	6.5 kg

All information is subject to change without notice.

SABROE VSD panel

Electrical panel solution for refrigeration compressor units with variable-speed drive (VSD)

SABROE VSD (Variable-Speed Drive) panel solutions are the ideal way to integrate the unique SABROE combination of refrigeration compressor unit know-how with electrical and controls experience and technologies. This paves the way to optimising the operation of refrigeration compressor units, and thus bring down here-and-now operating costs as well as longer-perspective life cycle costs for the owner.

SABROE VSD panels are integrated electrical panel solutions with a built-in frequency inverter and additional control equipment that together make them very easy to integrate into your overall power supply and control system.

Adding an optional Unisab III systems controller makes the VSD panel a complete plug-and-play controls and motor drive solution, ready to ensure your compressor package delivers maximum cooling power with minimum life cycle costs.

Factory-mounted units provide the best value for money, because delivering complete pre-vetted units ensures trouble-free operation and an electrical installation in full accordance with relevant standards and best practice. It also ensures end-users big savings on the man-hours required for configuring the overall equipment set-up.



SABROE VSD panel

Benefits of building in SABROE VSD panels

Competitive prices

SABROE VSD panels are competitively priced electrical panel solutions that contain a frequency inverter and everything needed for easy, compliant integration into the overall power supply and control system.

Saves you time

Integrating a SABROE VSD panel into any variable-speed compressor unit will shave off a major part of the man-hours normally allocated to electrical engineering, design, documentation, installation and commissioning of the compressor, chiller or heat pump unit.

Low life cycle cost

Combining a SABROE VSD panel with a Unisab III systems controller brings down the life cycle cost of the compressor unit as a whole. Improved part load characteristics (higher COP), achieved by a combination of the unique Unisab III yield control philosophy and the variable speed, along with the load-based service utility (service on demand) integrated in the Unisab unit, provide the owner with an extremely flexible compressor package with the big additional benefits of low life cycle costs.

The VSD panels are available for the SABROE compressor, chiller and heat pump units specified below. These panels are available as standard for power configurations up to 450 kW. Configurations up to 1000 kW available on request.

Factory-mounted

- ChillPAC chillers
- PAC chillers
- HeatPAC heat pumps.

Separate delivery for site mounting

- ChillPAC chillers
- PAC chillers
- HeatPAC heat pumps
- Screw compressors (all VSD-enabled)
- Reciprocating compressors (all VSD-enabled).

SABROE VSD panels are mounted in a standardised painted-steel cabinet, and include the following equipment:

- Electrical engineering, documentation and parameter settings list for the frequency inverter
- Danfoss FC102 frequency inverter, including RFI filter
- Unisab III controller for panel mounting (optional – must be selected separately)
- Main circuit breaker
- Control voltage transformer
- Emergency stop and emergency stop safety relay
- Motor protection
- Current signal to Unisab III
- Relays for signals to Unisab III
- Hour counter
- Terminals for interlock with pumps, etc.
- MCB for control voltage to panel
- MCB for control voltage to Unisab III
- MCB for power to immersion heater in oil separator
- Cable inlet/outlet in panel bottom.

Technical data

Power supply: 3x400 V, 50/60 Hz, +/-10%

Earthing/supply system: TN-S

Partitioning: Form 1

Colour: Light grey

Ingress protection class: IP54

Compliance: CE

Nominal output kW / amp	Dimensions in mm		
	W	H	D
22 kW / 44A	816	1434	624
30 kW / 61A	816	1434	624
37 kW / 73A	816	1434	624
45 kW / 90A	816	1434	624
55 kW / 106A	816	1434	624
75 kW / 147A	816	1434	624
90 kW / 177A	816	1434	624
110 kW / 212A	816	1626	624
132 kW / 260A	816	1626	624
160 kW / 315A	816	1818	624
200 kW / 395A	816	1818	624
250 kW / 480A	816	1818	624
315 kW / 600A	816	1818	624
355 kW / 658A	1200	2202	816
400 kW / 745A	1200	2202	816
450 kW / 800A	1200	2202	816

All information is subject to change without notice

SABROE SABflex VSD panel

Electrical panel solution for refrigeration screw compressors with variable-speed drive (VSD)

SABROE panel solutions for screw compressor units fitted with variable-speed drive are the ideal way to integrate the unique SABROE combination of refrigeration compressor know-how with electrical and controls experience and technologies. This paves the way to optimising the operation of refrigeration compressor units, and thus bring down here-and-now operating costs as well as longer-perspective life cycle cost for the owner.

The SABROE SABflex VSD solution for screw compressors is a compact split solution with a separate panel and VSD. The panel includes a Unisab III systems controller as standard.

The SABflex VSD solution is mainly intended for applications where both the inverter and panel are mounted directly onto the compressor unit, or where the inverter is positioned in a different place than the control panel.

Factory-mounted units provide the best value for money, because delivering complete pre-vetted units ensures trouble-free operation and an electrical installation in full accordance with relevant standards and best practice. It also ensures end-users big savings on the man-hours required for configuring the overall equipment set-up.



SABROE SABflex VSD panel

Benefits of building in SABROE SABflex VSD solutions

Competitive prices

SABROE SABflex VSD solutions are competitively priced and include a frequency inverter and a separate electrical control panel with a Unisab III systems controller and everything needed for easy, compliant integration into the overall plant power supply and control system.

Saves you time

Integrating a SABROE SABflex VSD solution into one of the listed variable-speed compressor units will shave off a major part of the man-hours normally allocated to electrical engineering, design, documentation, installation and commissioning of the compressor unit.

Low life cycle cost

The SABflex VSD solution with a Unisab III systems controller brings down the life cycle cost of the compressor unit as a whole.

Improved part load characteristics (higher COP), achieved by a combination of the unique Unisab III yield control philosophy and the variable speed, along with the load-based service utility (service on demand) integrated in the Unisab unit, provide the owner with an extremely flexible compressor unit with the big additional benefits of low life cycle costs.

The SABflex VSD solution is available for the SABROE screw compressor units specified below. These panels are available as standard for power configurations from 75 kW to 315 kW.

Factory-mounted (75–315 kW)

- SABflex
- SAB 120–151 series
- SAB 193 S
- CompPAC.

Separate delivery for site mounting

- SABflex
- SAB 120–151 series
- SAB 193 S.

SABROE SABflex VSD panel solutions comprise a frequency inverter and a control panel in a standardised painted-steel cabinet, containing the following equipment:

- Electrical engineering, documentation and parameter settings list for the frequency inverter
- Unisab III controller
- Main circuit breaker
- Control voltage transformer
- Emergency stop and emergency stop safety relay
- Motor protection
- Current signal to Unisab III for proactive overload counteraction
- Relays for signals to Unisab III
- Hour counter
- MCB for control voltage to panel
- MCB for control voltage to Unisab III
- MCB for power to immersion heater in oil separator
- Cable inlet/outlet in panel bottom.

Technical data - panel

Power supply: 3x400 V, 50/60 Hz, +/-10%
 Earthing/supply system: . . . TN-S
 Partitioning: Form 1
 Colour: Light grey
 Ingress protection class: . . . IP54
 Compliance: CE
 Dimensions in mm: W 600 x H 950 x D 400

Technical data - frequency inverter

Type: Danfoss FC102
 Filter included: RFI/EMI
 Ingress protection class: IP54
 Dimensions in mm . . . W x H x D
 75–90 kW: 370 x 770 x 330
 110–160 kW: 325 x 901 x 378
 200–315 kW: 420 x 1060 x 378

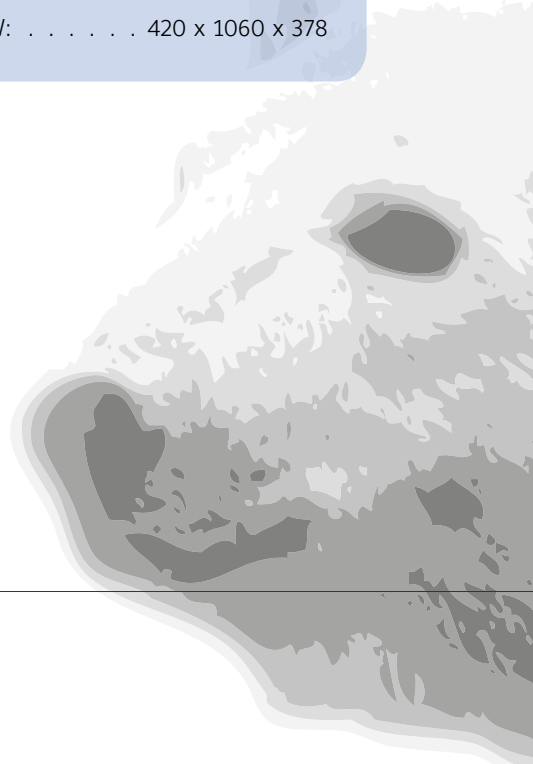

SABROE softstarter FSD panel

Electrical panel solution for refrigeration compressor units with fixed-speed drive (FSD)

SABROE panel solutions for compressor units fitted with fixed-speed motors are the ideal way to integrate the unique SABROE combination of refrigeration compressor know-how with electrical and controls experience and technologies. This paves the way to optimising the operation of fixed-speed refrigeration compressor units, and thus bring down here-and-now operating costs as well as longer-perspective life cycle costs for the owner.

SABROE softstarter FSD panels are integrated electrical panel solutions with a built-in softstarter and additional control equipment that together make them very easy to integrate into your overall power supply and control system.

Adding an optional Unisab III systems controller makes the softstarter FSD panel a complete plug-and-play controls and motor starter solution, ready to supply the motor and ensure that the fixed-speed compressor unit delivers maximum cooling power at a minimum life cycle cost.

SABROE softstarter FSD panels are an advanced electronic alternative to conventional Y/D starters, enabling a smoother start and (in some setups) making it possible to reduce the starting current better than a Y/D starter.



SABROE softstarter FSD panel

Benefits of building in SABROE softstarter FSD panels

Competitive prices

SABROE softstarter FSD panels are competitively priced electrical panel solutions that contain a softstarter FSD and everything needed for easy, compliant integration into the overall power supply and control system.

Saves you time

Integrating a SABROE softstarter FSD panel into any fixed-speed compressor unit will shave off a major part of the man-hours normally allocated to electrical engineering, design, documentation, installation and commissioning of the compressor, chiller or heat pump unit.

Low life cycle cost

Combining a SABROE softstarter FSD panel with a Unisab III systems controller brings down the life cycle cost of the compressor unit as a whole. The unique Unisab III yield control philosophy along with the load-based service utility (service on demand) integrated in the Unisab unit, provides the owner with an extremely flexible and low life cycle cost compressor unit.

Softstarter FSD panels are available for the SABROE compressor, chiller and heat pump units specified below. These panels are available as standard for power configurations up to 560 kW. Configurations above this are available on request.

Factory-mounted

- ChillPAC chillers
- PAC chillers
- HeatPAC heat pumps
- CompPAC.

Separate delivery for site mounting, all on request

- ChillPAC chillers
- PAC chillers
- HeatPAC heat pumps
- All screw compressors
- All reciprocating compressors.

Factory-mounted units provide the best value by ensuring trouble-free operation and an electrical installation in full accordance with relevant standards and best practice. It also ensures end-users big savings on the man-hours required for configuring the overall equipment set-up.

SABROE softstarter FSD panels are mounted in a standardised painted-steel cabinet, and include the following equipment:

- Electrical engineering and documentation
- ABB softstarter
- In-line contactor for breaking power supply in case of emergency stop
- Unisab III controller for panel mounting (optional – must be selected separately)
- Main circuit breaker
- Control voltage transformer
- Emergency stop and emergency stop safety relay
- Motor protection
- Current signal to Unisab III
- Relays for signals to Unisab III
- Hour counter
- Terminals for interlock with pumps, etc.
- MCB for control voltage to panel
- MCB for control voltage to Unisab III
- MCB for power to immersion heater in oil separator
- Power inlet in panel top.

Technical data

Power supply: 3x400 V, 50/60 Hz, +/-10 %

Earthing/supply system: TN-S

Partitioning: Form 1

Colour: Light grey

Ingress protection class: IP54

Compliance: CE

Nominal output kW	Dimensions in mm		
	W	H	D
15	600	600	200
22	600	600	200
30	600	600	200
37	600	800	300
45	600	800	300
55	600	800	300
75	800	1000	300
90	800	1000	300
110	800	1000	300
132	800	1000	300
160	800	1200	300
200	1000	1400	300
250	1000	1400	300
315	1000	1400	300
355	1000	1800	400
400	1000	1800	400
450	1000	1800	400
500	1000	1800	400
560	1000	1800	400

All information is subject to change without notice

SABROE Y/D starter FSD panel

Electrical panel solution for refrigeration compressors with fixed-speed drive (FSD)

SABROE panel solutions for compressor units fitted with fixed-speed motors are the ideal way to integrate the unique SABROE combination of refrigeration compressor know-how with electrical and controls experience and technologies. This paves the way to optimising the operation of fixed-speed refrigeration compressor units and thus bring down here-and-now operating costs as well as longer-perspective life cycle cost for the owner.

SABROE Y/D starter panels are integrated electrical panel solutions with conventional Y/D starters and additional control equipment that together make them very easy to integrate into your overall power supply and control system.

Adding the optional Unisab III systems controller to the panel makes the Y/D starter panel a complete plug-and-play controls and motor starter solution, ready to supply the motor and ensure that the fixed-speed compressor package delivers maximum cooling power at a minimum life cycle cost.



SABROE Y/D starter panel

Benefits of building in SABROE Y/D starter panels

Competitive prices

SABROE Y/D starter FSD panels are competitively priced electrical panel solutions that contain a Y/D starter and everything needed for easy, compliant integration into the overall plant power supply and control system.

Saves you time

Integrating a SABROE Y/D starter FSD panel into a fixed-speed compressor unit will shave off a major part of the man-hours normally allocated to electrical engineering, design, documentation, installation and commissioning of the compressor, chiller or heat pump unit.

Low life cycle cost

Combining a SABROE Y/D starter FSD panel with a Unisab III systems controller brings down the life cycle cost of the compressor unit as a whole. The unique Unisab III yield control philosophy along with the load-based service utility (service on demand) integrated in the Unisab unit, provide the owner with an extremely flexible compressor package with the big additional benefits of low life cycle costs.

Y/D starter FSD panels are available for the SABROE compressor, chiller and heat pump units specified below. These panels are available as standard for power configurations up to 560 kW. Configurations above this are available on request.

Factory-mounted

- ChillPAC chillers
- PAC chillers
- HeatPAC heat pumps
- CompPAC.

Separate delivery for site mounting, all on request

- ChillPAC chillers
- PAC chillers
- HeatPAC heat pumps
- All screw compressors
- All reciprocating compressors.

Factory-mounted units provide the best value for money, because delivering complete units ensures trouble-free operation and an electrical installation in full accordance with relevant standards and best practice. It also ensures end-users big savings on the man-hours required for configuring the overall equipment set-up.

Technical data
 Power supply: 3x400 V, 50/60 Hz, +/-10%
 Earthing/supply system: TN-S
 Partitioning: Form 1
 Colour: Light grey
 Ingress protection class: IP54
 Compliance: EN60 204-1

SABROE Y/D starter FSD panels are mounted in a standardised painted-steel cabinet, and include the following equipment:

- Electrical engineering and documentation
- Y/D starter
- Unisab III controller for panel mounting (optional – must be selected separately)
- Main circuit breaker
- Control voltage transformer
- Emergency stop and emergency stop safety relay
- Thermal overload motor protection
- Current signal to Unisab III for proactive overload counteraction
- Relays for signals to Unisab III
- Hour counter
- Terminals for interlock with pumps, etc.
- MCB for control voltage to panel
- MCB for control voltage to Unisab III
- MCB for power to immersion heater in oil separator
- Power inlet in panel top.

Nominal output kW	Dimensions in mm		
	W	H	D
15	600	600	200
22	600	600	200
30	600	600	200
37	600	800	300
45	600	800	300
55	600	800	300
75	800	1000	300
90	800	1000	300
110	800	1000	300
132	800	1000	300
160	800	1200	300
200	1000	1400	300
250	1000	1400	300
315	1000	1400	300
355	1000	1800	400
400	1000	1800	400
450	1000	1800	400
500	1000	1800	400
560	1000	1800	400

All information is subject to change without notice

SABROE chiller plant controller

Integrated solution for managing and monitoring the controls equipment in chiller plants

The SABROE chiller plant controller is a compact, easy-to-install control panel that contains a pre-programmed PLC system and touch panel for monitoring and controlling a wide range of external equipment that is not part of the chiller itself, but that serves the chilled water distribution system as well as other key equipment in the chiller plant.



Advantages and benefits of the SABROE chiller plant controller

Combines advanced technology and operating data to leverage the operational benefits of modern chillers

Consolidates industrial refrigeration and chilled water plant control know-how and experience into one single control box

Paves the way to streamlined operation of a wide range of chiller plant functions

Compact, fully integrated solution, which is easy to link up to the vast majority of chiller plant set-ups

Saves on engineering time, and makes plant and chiller integration and commissioning easier

Can be used for remote monitoring and remote operation

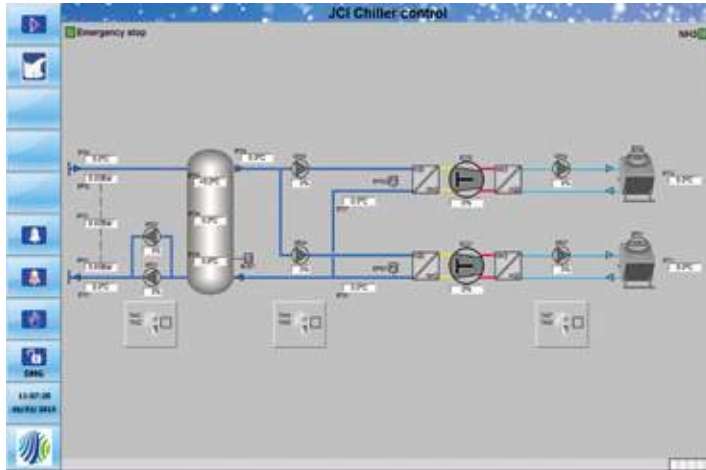

The chiller plant controller includes

- Differential pressure monitoring and control of pumps on the consumer side of the buffer tanks
- Buffer tank temperature control function, with remote start/stop of chillers
- Low-temperature protection of condenser circuit
- Optimum condensing pressure control of condenser side, to match changing outdoor conditions
- Monitoring of temperatures and pressures, and of the functioning of switches, motors and valves
- Choice of direct or VSD drive control for each motor. VSD control can be by conventional digital/analogue signals or by Profinet data communication with the VSDs
- Remote monitoring and plant operation capability, via internet
- Remote monitoring of connected Unisab IIIs.

The SABROE chiller plant controller provides users with straightforward on-screen configuration of equipment throughout the chiller plant. You simply select the number and type of chillers, the type and number of condensers, the condenser control method and the distribution system design, including buffer tank option.

You also simply click on the number and functions of sensors, valves, pumps and fans.

Connectivity options

The chiller plant controller is available with a 3G/4G modem and VPN router for wireless internet connection.

The type and make of drive for pumps and for condenser fans are configurable. You can choose between conventional starter methods and VSD drive. The VSD drive option means you can use Danfoss and ABB VSD drives featuring Profinet connectivity and extended monitoring.

Control panel specifications

Cabinet	1000 x 800 x 300 mm (HxWxD) painted steel plate, IP44
Connectivity	Touch panel: Ethernet interface for remote monitoring and operation PLC: Ethernet/Profinet interface for software service and connectivity to VSDs
Main components	Main switch, 24V DC power supply, relays and terminals, Siemens S7-1500SP PLC and 12-inch Siemens Comfort touch panel

All information is subject to change without notice

SABROE CP Optimiser

Automatic device for balancing R717 condensing pressure against compressor efficiency

Many refrigeration systems that use R717 (ammonia) as refrigerant and feature an evaporative condenser are operated using a fixed set point to maintain a constant condensing pressure. This is rarely ideal, as the energy consumption of the compressors typically increases by 3% for every °C the condensing pressure rises – shaft power consumption is directly influenced by condensing pressure. This impacts overall operating costs and plant efficiency.

Reducing condensing pressure improves compressor efficiency, but doing so also requires energy. Maximum overall efficiency stems from the best possible balance between compressor energy consumption and the energy required to reduce condensing pressure. The figure below indicates the sum total displacement of the energy consumption, if the condensing pressure deviates from optimum.

The CP Optimiser automatically calculates this energy balance, taking into account changing loads and conditions. This paves the way to considerable savings on energy bills, which means the CP Optimiser normally pays for itself within a matter of months.

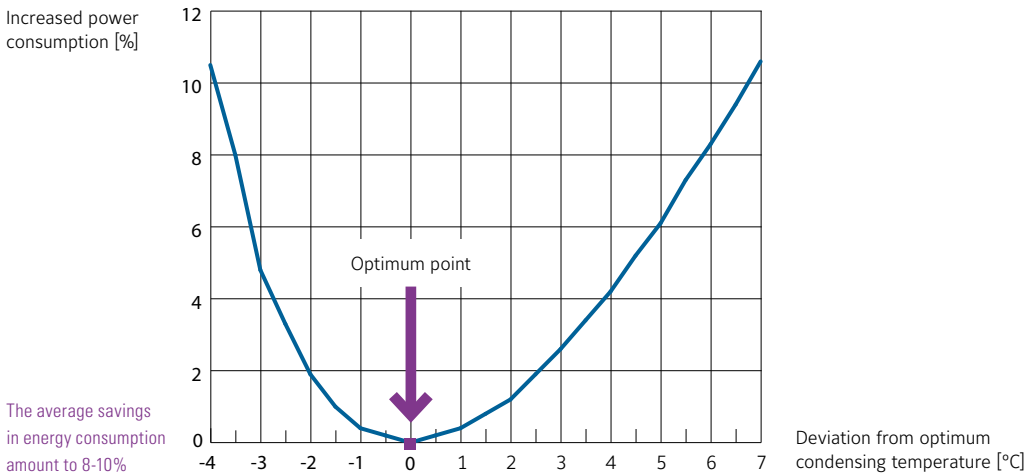

Advantages

Automatic operation based on inputs from just two sensors – temperature and humidity

Output signal can be connected directly to PLCs and frequency converters

No time-consuming programming or complicated technical set-up required

No manual intervention or special operator skills required

No special requirements for integration into new or existing R717-based refrigeration set-ups

Benefits

Substantial reduction in compressor energy consumption, resulting in lower operating costs

Easy to integrate with modern monitoring and control systems to ensure maximum efficiency

Easy to commission and operate, and helps eliminate human error

Virtually no maintenance, calibration or attention necessary after commissioning

Straightforward, inexpensive way to boost operating efficiency and reduce running costs

Where it's used

The CP Optimiser is highly recommended for inclusion in all new installations.

Installing the CP Optimiser in existing installations provides immediate savings on electricity costs.

The CP Optimiser works with the following equipment:

- Evaporative condensers
- Air-cooled condensers
- Dry cooler
- Open cooling towers.

Mounting

The CP Optimiser unit is a small box of electronics that is easy to mount in virtually any convenient location, either indoors or outdoors.

The unit only requires a 24-volt DC power supply and data from appropriate sensors for measuring temperature and relative humidity.

Integration of the CP Optimiser

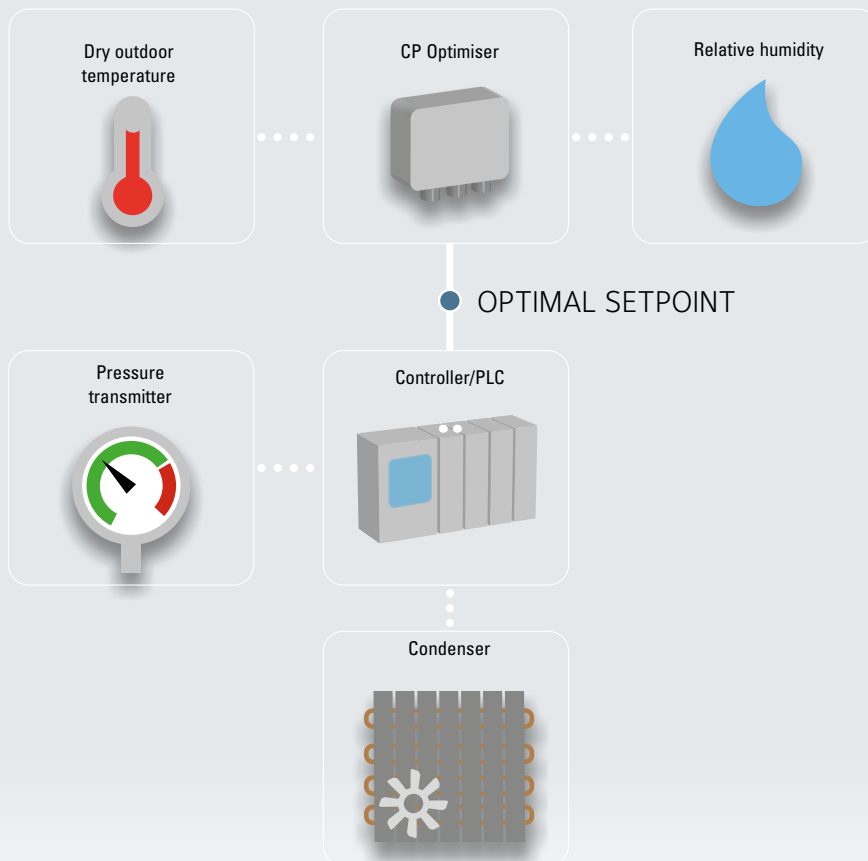

Supply voltage	. . .	24-volt DC
Inputs	Temperature 4–20 mA/0–50°C
Relative humidity	. . .	4–20 mA/0–100% RH
Outputs	Setpoint signals configurable to 4–20 mA or 0–10 volt DC
Dimensions (H x W x D)	115 x 90 x 55 mm
Enclosure	IP54
Cable connections	. . .	4 x PG7

Temperature and relative humidity sensors are not included with the SABROE CP Optimiser, but are available as optional equipment.
Controller (PLC) not included.

SABROE Integrated Standard Automation Concept (ISAC)

Monitoring and control interface configuration system for industrial refrigeration installations

ISAC is a unique SABROE software with a toolbox for designing and configuring refrigeration control and monitoring set-ups of virtually all kinds. It provides an effective way to integrate SCADA graphics with PLC functionality in order to ensure effective, reliable monitoring and control of both large and small industrial refrigeration installations.

ISAC modules provide standardised, pre-vetted solutions for almost any installation, based on consistent, industry-standard data inputs and outputs that ensure seamless, glitch-free exchanges of data between many different kinds of equipment, regardless of capacity, configuration or manufacturer.



Advantages

Extensive SABROE practical experience is embedded in all ISAC modules

All modules are designed as modular building blocks and based on standardised interfaces and data exchange configurations

Each module designed and tested individually to eliminate technical incompatibilities

Supports a wide range of standard configurations, ranging from single touch screens to multiple workstations

Based on standardised components with a very high degree of documentation, for maximum consistency and efficiency

Benefits

Ensures rapid, cost-effective application of best practise

Minimises time required for design, planning, configuration and service

Greater safety, greater reliability and lower operating costs

Easy to scale to the exact functionality required

High saving potential on commissioning, running in and system optimisation, as well as on energy consumption

Where and how ISAC can be used

The SABROE ISAC system is easily scalable to meet a broad spectrum of refrigeration plant configurations. It provides advanced, flexible control functions with intuitive user features designed for the best match with the performance and technical requirements of each installation.

The ISAC system toolbox is designed to enable controls application engineers with only basic PLC and SCADA programming skills to build advanced, structured and error-free program applications. Once engineers are familiar with the toolbox and how to use it, ISAC makes it possible to build applications much faster than with conventional programming methods.

Extensive field and factory testing of the ISAC toolbox ensures error-free modules and paves the way to smooth, effective commissioning without the usual subsequent adjustments and fault corrections.

Access to the ISAC toolbox requires membership of the ISAC user community, and the ISAC community administrators provide new members with free training courses.

ISAC is easily applicable to both new and existing refrigeration setups, including extension schemes and retrofits of complete refrigeration plants.

Standard features

- Defrost queue, automatic temperature-controlled defrost time, multiple room temperature control setups, etc.
- Automatic equalisation of running hours in installations with multiple pumps and fans
- Differential pressure control of NH₃ pumps
- Manual control possibility of all motors, valves and other actuators
- Hour counters for all motors
- Historical trending
- Alarm and shutdown monitoring
- And more.

ISAC is based on – and completely compatible with – industry-standard Siemens S7 hardware and GE IFIX Proficy SCADA software.

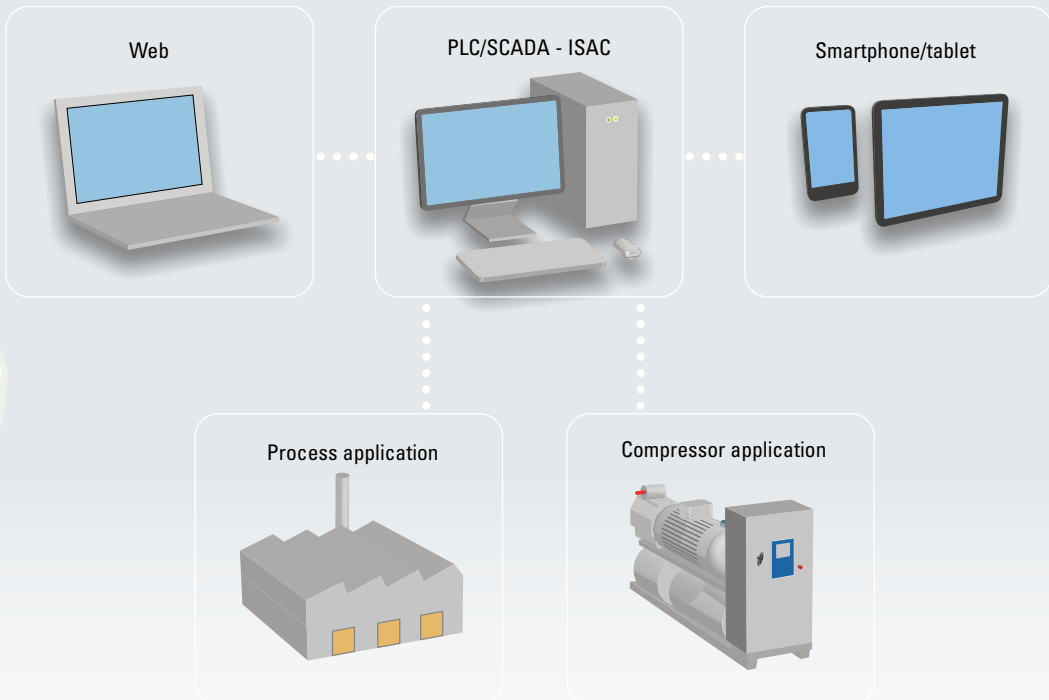

SABROE Intelligent Remote Information Services (iRIS)

Reporting and documentation system supporting fully-informed decisions on plant optimisation

Intelligent Remote Information Services (iRIS) is a unique SABROE software platform (managed by Johnson Controls) that registers, captures and collates performance data from all types of industrial refrigeration and thermal transfer equipment.

The iRIS system processes data such as:

- Load distribution and power consumption
- Performance patterns and fluctuations over time
- Statistics for shutdowns and alarms to reveal any irregularities in operation
- Comparisons and benchmarking between the different plants in a company, and operations in different countries.

The iRIS system is part of a complete service concept, working on the basis of information collected and structured by the iRIS server to form different reports and services. These are available by subscription, tailored to the requirements of each individual installation.



Advantages	Benefits
Reliable, comprehensive operating data documenting what is actually happening in the refrigeration installation	Best possible basis for streamlining and optimising operations based on documented facts
Performance and energy consumption benchmarks on a comparative basis	Greater capacity, reduced energy consumption and better plant performance
More cost-effective operations and solid facts for maintenance and extension	Solid operating data as the basis for decisions about new investment and new equipment configurations
Identifying potential problems and inefficiencies before they give rise to disruption	Predictive maintenance and lower service costs
Analysis and guidance by refrigeration technology experts	Access to world-class technical assistance and optimisation knowledge

Compatibility/integration

The iRIS software platform can be adapted to a wide range of refrigeration systems, right from individual compressors to complete refrigeration plants, and is equally well suited for new installations and existing plants.

iRIS is designed to interface seamlessly with Unisab III compressor controllers and plant control systems designed using ISAC toolbox modules. It is also possible to integrate with other systems where data are made available.

Advantages of comparative analysis

The ground-breaking iRIS platform enables owners and operators of refrigeration systems to benefit from solid comparative data, built up over an extended period. This valuable data is automatically stored, structured and presented so that it can be interpreted and applied by Johnson Controls refrigeration technology experts, to tweak and streamline the plant's operating profile.

Customers benefit from direct access to all the expertise and experience available from one of the world's biggest companies in this field – and on the basis of documented performance data.

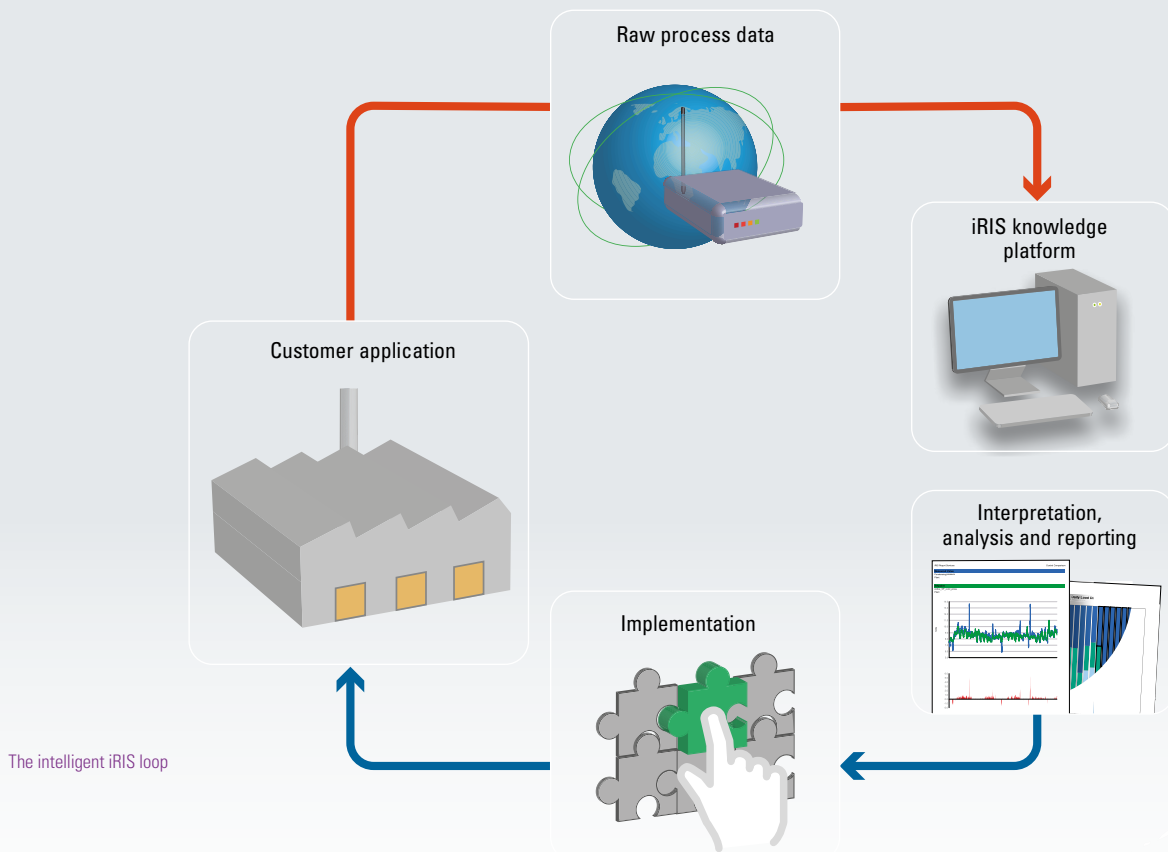

All information is subject to change without notice.

SABROE customised solutions

SABROE has an extremely comprehensive portfolio of standard industrial refrigeration solutions. Sometimes, however, this just isn't enough to meet a customer's very specific operating requirements or installation opportunities. In such cases, we partner with our customers to customise one or more SABROE solutions to comply with the particular requirement.

SABROE customised solutions feature maximum flexibility, in order to support the engineering of solutions that comply with any special customer requirement. These are just some of the options normally available – ask SABROE experts about more.

Multiple configurations, many options, maximum capability. You decide exactly what best suits your operating priorities.

- Compliance with special design codes and national technical requirements
- Wide range of refrigerants and gases
- Special brines and secondary refrigerants
- Special configurations for installation in
 - Hazardous environments
 - Explosive environments
 - Corrosive environments
 - Low and high ambient temperatures
- Special compressor units for gas transfer
- Dual compressor packs
- Customised chiller and heat pump packages
- High-temperature heat pumps
- High-capacity chillers and heat pumps
- Ultra-low-temperature process cooling
- Skid-mounted systems – single or modular
- Associated systems, including ventilation, hydraulic solutions, etc.
- Special control systems including PLC, and any type of SCADA control system architecture
- Special instrumentation
- Special electrical panels
- High-voltage motors.



In SABROE customised solutions, research and development go hand in hand with ingenuity and experience. Each project is managed by a matrix team consisting of the appropriate specialists and other highly skilled staff.

Great flexibility throughout ensures product quality and appropriate technical compliance as well as on-time, on-spec delivery.

All SABROE customised products are subject to factory acceptance testing (FAT) in the SABROE End-of-Line test centre (EOL). This means we carry out extensive checks on capacity, performance, vibration and control functions prior to delivery. Any customer is welcome to participate in or supervise these tests.



Customised

All information is subject to change without notice.

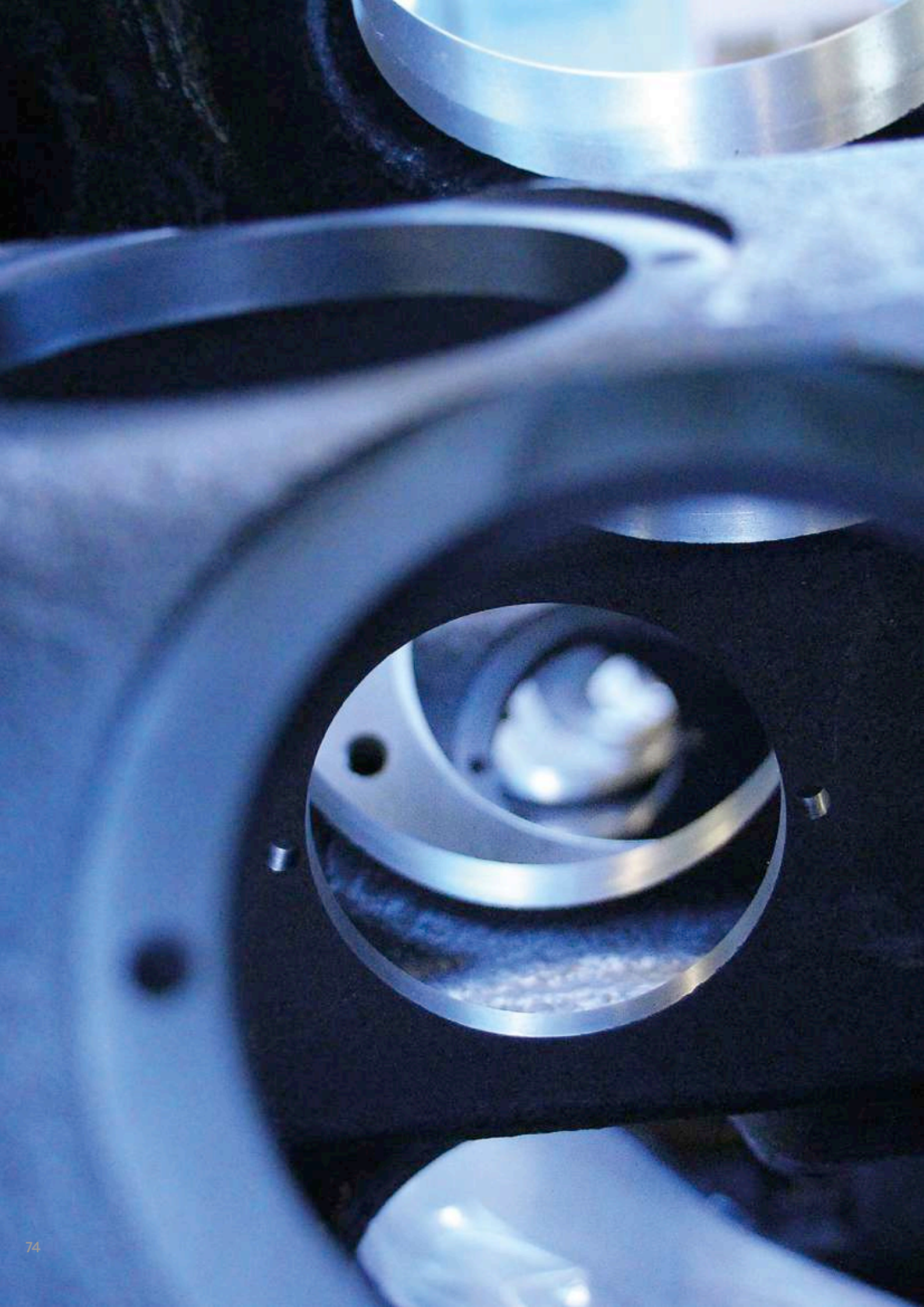

Long service life saves you money

Tested to ensure reliability

SABROE® products and systems are renowned for exceptional reliability and technological advantages, backed by our ability to meet even the most demanding customer requirements.

One of the big advantages of doing business with SABROE® is that our compressor, chiller and heat pump products are all systematically tested before delivery. This ensures rapid, glitch-free commissioning and a bare minimum of interruption to your operations.

Industrial Refrigeration Parts Centre

The Industrial Refrigeration Parts Centre provides round-the-clock aftermarket support services that enable both owners and providers of SABROE® equipment all over the world to maximise their return on investment, and to ensure the long-term efficiency and stability of their operations.

Making the most of an effective worldwide logistics infrastructure and rapid-response inventory management, the Parts Centre dispatches any part to wherever in the world it may be needed, within just 24 hours (if the part is in stock).

www.sabroe.com/en/parts/



SMC Long-life upgrade kit

EasyParts – online ordering of Industrial Refrigeration parts

- 40,000 items, of which 7,000 are in stock
- Easy item search and ordering
- Integrated enquiry system for technical support and warranty
- Shipment tracking and invoice download.

<https://easyparts.johnsoncontrols.com>

AfterMarket

AfterMarket Solutions (AMS)

The AfterMarket Solutions facility is the overhaul, repair, re-manufacturing and stock centre for Johnson Controls industrial refrigeration companies throughout the world.

The AMS centre makes it easy to significantly extend the service life of your SABROE® equipment, to minimise downtime and to reduce the operating costs of refrigeration installations by replacing worn compressor blocks, or getting existing blocks overhauled or repaired – all with a minimum of practical bother and service interruption.

Attractive retrofit options are also available.

www.sabroe.com/en/aftermarket-solutions/



SABROE AP1000 air purger

Improves performance and reduces operating costs for all types of industrial ammonia refrigeration equipment

The AP1000 Air Purger is specially designed to maintain the efficiency of an ammonia-based refrigeration setup by removing any air present in the refrigerant charge. Air is an un-condensable gas that reduces the effective surface of the condenser and evaporators, resulting in poorer refrigeration performance and higher operating costs.

Any air entering the refrigeration equipment also contains moisture. The mix of water, oxygen and ammonia tends to break down the compressor oil, resulting in loss of viscosity and lubricating properties and premature wear of compressor parts.

Removing air restores any gradual loss of refrigeration capacity, thus making it possible to either increase any production related to refrigeration output, or to reduce energy consumption. Typical performance improvements average 5–10% of the overall refrigeration capacity, or a corresponding 5–10% reduction in power consumption.

The AP1000 features an easy-to-connect control box connected to both the air purger and up to 16 purge points, via settings entered with the 4-inch touch screen on the front of the electrical panel. The box is prepared for connecting additional purge box modules, if more than 16 purge points are required.



Advantages	Benefits
Protects against gradual reductions in cooling capacity	Greater cooling capacity
Constantly purges efficiency-sapping air from refrigeration equipment	Reduced energy consumption for refrigeration equipment (normally 5–10%)
Uncomplicated design	Rapid return on investment (normally less than 12 months for medium-sized plants)
No maintenance required	Less oil decomposition and fewer unexplained refrigeration equipment stoppages
Easy to install	More stable operation Lower refrigeration service and maintenance costs

Installing the AP1000 air purger

Installation of the air purger, as illustrated below, is fairly simple. A solenoid valve must be fitted in each purge point line and connected to the control box.

How to operate

The control box monitors the level indicator in the vessel as well as controlling the three solenoid valves on the air purger itself and up to 16 solenoid valves mounted in purge lines.

Settings for the on and off periods of the purge point solenoid valves are entered on the touch panel.

Remote monitoring and control of the air purger:

- Green lamp indicates purge active
- Red lamp indicates fuse fault
- Remote activation of the air purger (potential-free "HP compressor running" signal to digital input)
- Remote monitoring of fuse fault (potential-free contact).

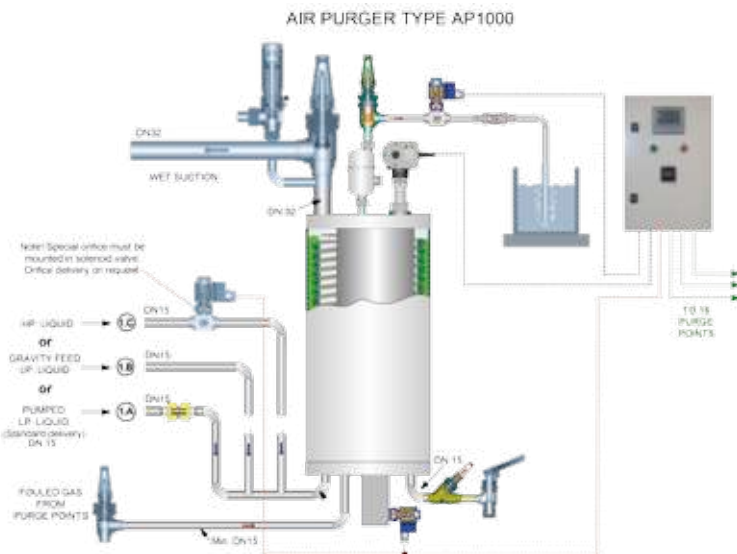

Technical data for the AP1000 air purger

Material Carbon steel/stainless steel
 Dimensions H x W x D 1300 x 550 x 370 cm
 Condensing capacity 10 to 13 kW
 Refrigerant Mainly suited for R717
 Ingress protection IP65
 Compliance CE/PED 97/23/EC

Technical data for the control box

Power supply 230VAC 50HZ
 Dimensions H x W x D 600 x 400 x 300 mm
 Encapsulation/
 Ingress protection Painted-steel plate/IP54
 Contents Main switch
 Siemens S7-1200 PLC
 Siemens KTP400 Basic 4-inch
 Lamps indicating operation
 and fault
 Relays on outputs
 Output voltage for solenoids 230 VAC 50 Hz
 Compliance CE

SABROE WDO Water, Dirt and Oil Purifier

For removing any water or oil present in the refrigerant charge

WDO Purifiers maintain refrigeration plant efficiency by reducing the amounts of water and oil in the refrigerant. This in turn makes it possible to roll back operating costs as well as any risk of unscheduled plant shutdowns.

WDO Purifiers reduce water contamination in ammonia plants, as well as benefiting refrigeration capacity, power consumption and operating costs. Without a WDO unit, any water present in the refrigerant will almost certainly have a negative impact on overall plant performance.

For a typical ammonia-based refrigeration setup, removing unwanted water can help reduce power consumption by as much as 5–10%. For a medium-sized plant, a WDO Purifier normally has a payback time of less than 12 months.



SABROE WDO Purifier

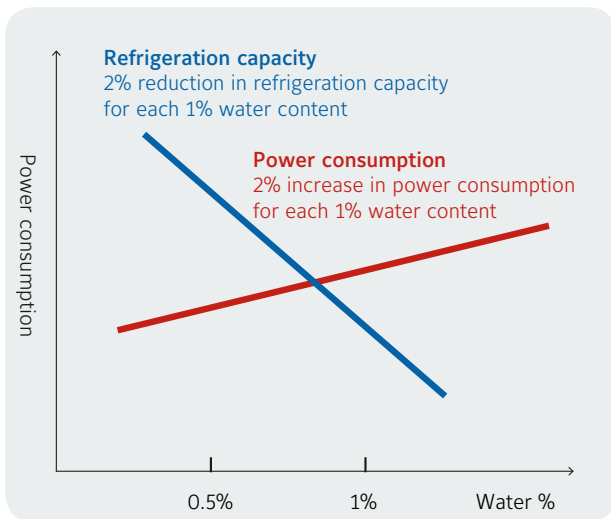

Advantages	Benefits
Removes oil and dirt from your refrigeration installation	Reduces operating costs and keeps system components operating at maximum efficiency
Removes any water present in the ammonia refrigerant	Less corrosion of mechanical parts, along with fewer breakdowns and unscheduled service interruptions
Fewer oil changes needed	Prevents any water present in the refrigerant degrading the lubricating oil and reducing operating efficiency and service life

Two versions available

WDO-HE with electrical heating element

WDO-hot gas for hot gas

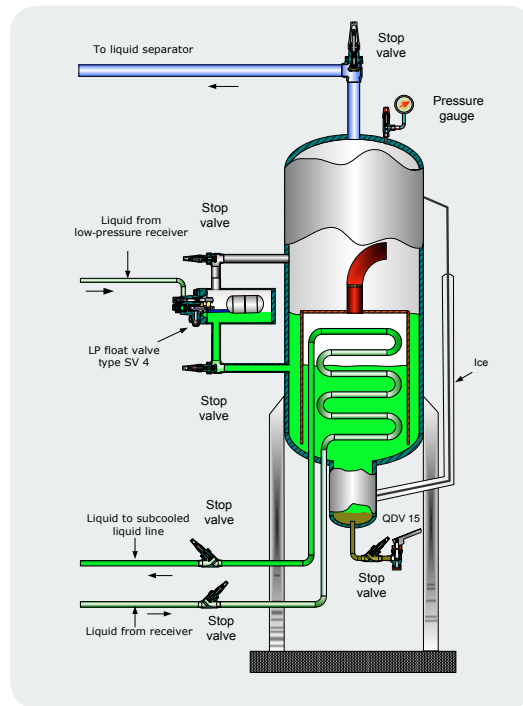
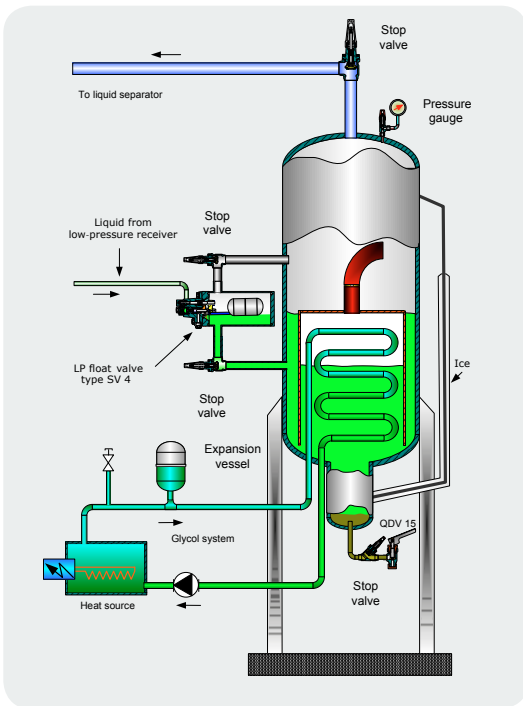

Technical data

Refrigerant charge 35 kg
 Maximum operating pressure . . . 24 bar
 Surface of R717 separator 1.2 m²

Operating limits

Lowest operating temperature . . . -40°C
 Highest operating temperature . . . 50°C

Unit dimensions H x W x L 2000 x 800 x 1100 mm
 Weight, empty 389 kg

Power supply (for WDO-HE version only)

Voltage 3 x 400 V, 50 Hz
 Consumption 6.5 amp
 Maximum fuses in supply 16 amp

SABROE End-of-Line test centre

Full satisfaction – no surprises

Not only are SABROE systems at the forefront of industrial refrigeration technology, they're also backed by state-of-the-art facilities for pre-delivery, pre-commissioning testing.

We rigorously test the performance of every unit before it leaves the factory, so you can be 100% sure it lives up to your expectations in full when it arrives. You're entitled to expect full transparency – and we make sure SABROE systems deliver.

All SABROE chiller units are tested before dispatch

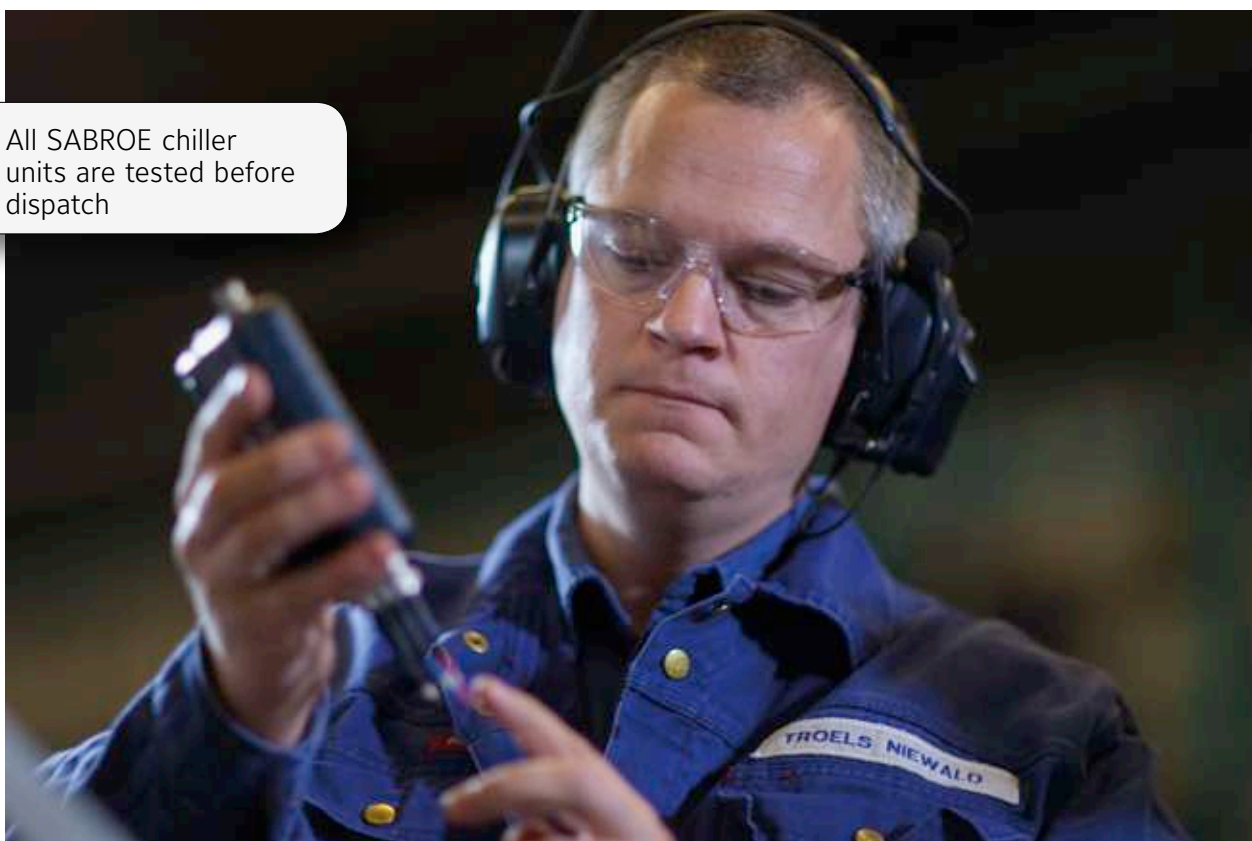

Testing in the factory – not on site

The unique SABROE End-of-Line (EOL) test centre, located in Denmark, is a purpose-built facility comprehensively equipped with state-of-the-art monitoring and testing equipment.

We can conduct a comprehensive range of tests, ranging from full-blown Factory Acceptance Test (FAT) to any specific test package you may prefer. You and your staff are, of course, welcome to witness every stage of tests and trial runs to make sure everything performs as intended, with no unwelcome surprises.

Documented capabilities

Rigorous pre-commissioning testing gives you comprehensive, reliable documentation of the performance and capabilities of the exact equipment you'll be receiving – not just generic approximations.

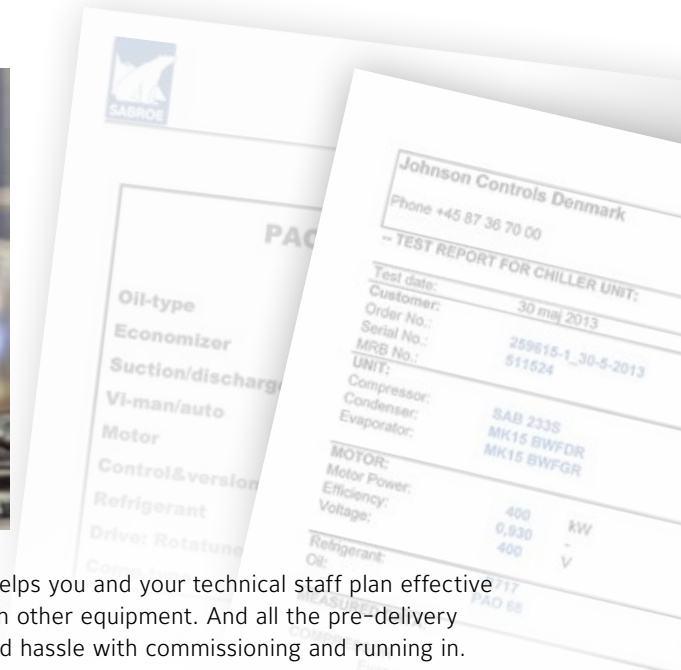

Solid, dependable documentation helps you and your technical staff plan effective implementation and integration with other equipment. And all the pre-delivery tests help save you time, money and hassle with commissioning and running in. With SABROE product deliveries, you get what you ordered – and it works as you expected.



Test stands in the End-of-Line test centre

120 years of new ideas and better technology



2017 - DualPAC
2017 - SMC Mk 4 LL
2017 - SAB series 40 bar
2017 - Chiller Plant Controller (CPC)
2016 - ComPAC
2015 - HeatPAC HPX
2015 - ChillPAC Mk 3
2013 - SABflex
2011 - SABlight
2011 - iRIS
2010 - HeatPAC
2007 - Unisab III
2006 - SABcube
2006 - CAFP
2005 - SABscrew redesign
2004 - ChillPAC
2002 - Variable-speed drive
1995 - Unisab II
1995 - PAC
1994 - SAB 202
1991 - SAB 110
1989 - Unisab I
1989 - HPO, HPC
1988 - Prosab II
1985 - μ Prosab
1985 - SAB 163
1982 - SAB 128
1967 - First heat pump
1965 - CMO
1955 - SMC
1929 - SA
1897 - First CO₂ compressor
1897 - Introduction of natural refrigerants
1897 - SABROE founded

We've proved we can repeatedly and consistently meet our customers' needs – regardless of size and complexity, quirkiness or challenge.

We listen to where your real difficulties lie, and what you really want to achieve. And then we focus 120 years of specialist experience and know-how on how best to help you achieve it all.

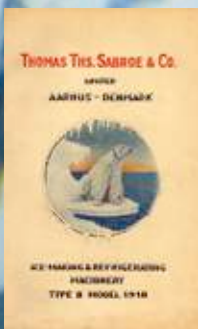

Your local representative



Johnson Controls Denmark ApS
SABROE Factory
Christian X's Vej 201 · 8270 Højbjerg · Denmark
Phone +45 87 36 70 00 · Fax +45 87 36 70 05
www.sabroe.com

